

**Slim, Space-saving,  
4-point Unit Relay**

**RT-3 UNIT RELAY  
4-POINT TERMINAL**

[PA-N Relay type, PhotoMOS Power  
(Voltage sensitive type)]

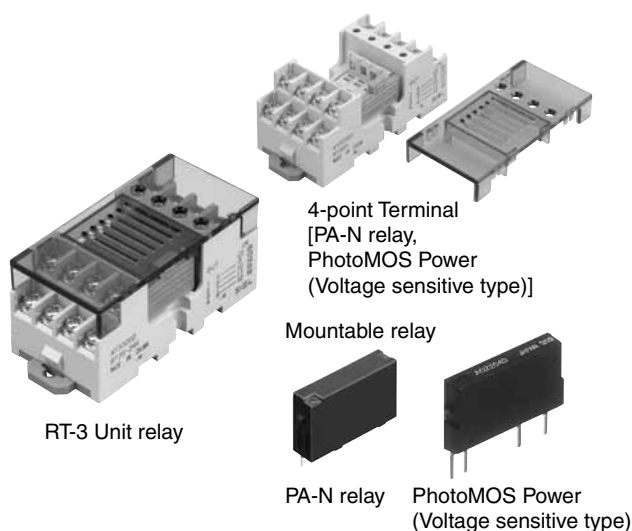

### FEATURES

1. Slim, space-saving type (33 mm 1.299 inch wide) with four independent points on a base measuring 33 × 67 mm 1.299 × 2.638 inch. This contributes to a more compact control panel.
2. Can be mounted on a DIN rail or mounted directly (by screw).
3. Equipped with an LED display to allow easy confirmation of operation.
4. Possible to select a relay for use in the 4-point terminal in accordance with its application.

**RoHS compliant**

## TYPES

### 1. RT-3 Unit relay

Contact arrangement	Rated input voltage	Part No.
1 Form A × 4	12 V DC	RT3SN-12V
	24 V DC	RT3SN-24V

Standard packing: Carton: 1 pc.; Case: 20 pcs.  
Note: PA-N relays are installed.

### 2. 4-point Terminal

Type	Rated input voltage	Part No.
PA-N relay, PhotoMOS Power type (Voltage sensitive type)	12, 24V DC	RT3BB

Standard packing: Carton: 1 pc.; Case: 20 pcs.

### 3. Mountable relays for 4-point Terminal (per relay, at 25°C 77°F, initial)

Product Name	Part No.
PA-N relay	APAN3112, APAN3124
PhotoMOS Power type (Voltage sensitive type)	AQZ10*D (DC only)
	AQZ20*D (AC/DC dual use)

Notes: 1. Never install relays into this product other than those given above. Doing so will cause malfunction, breakdown, and breakdown of the connected product.  
2. Cannot be equipped with PhotoMOS Power standard type relays. However, equipping with voltage-sensitive type of PhotoMOS Power type is possible.

## RATING

### 1. RT-3 Unit relay

#### 1) Input ratings (per PA-N relay)

Part No.	Rated input voltage	Input current (at rated input voltage, 20°C 68°F)	Allowable variation of rated input voltage (-20 to +55°C -4 to +131°F)
RT3SN-12V	12 V DC	Approx. 10.7 mA (Relay 9.2 mA + LED 1.5 mA)	12 V DC ± 10%
RT3SN-24V	24 V DC	Approx. 7.6 mA (Relay 4.6 mA + LED 3.0 mA)	24 V DC ± 10%

# RT-3 Unit Relay/4-point Terminal (PA-N Relay type)

## 2) PA-N relay coil specifications (Reference value)

Relay part No.	Pick-up voltage (Initial) (at 20°C 68°F)	Drop-out voltage (Initial) (at 20°C 68°F)	Coil resistance (±10%) (at 20°C 68°F)	Rated operating power
APAN3112	70%V or less of Rated voltage (initial)	5%V or more of Rated voltage (initial)	1,309 Ω	110 mW
APAN3124			5,236 Ω	110 mW

## 3) Output ratings (per PA-N relay)

Specification	Item	Specifications
Contact data	Contact rating (Resistive load)	3 A 250 V AC, 3 A 30 V DC
	Max. switching power (Resistive load)	750 VA (AC), 90 W (DC)
	Max. switching voltage	250 V AC, 30 V DC
	Max. switching current	3 A
	Min. switching load (Reference value)	1 mA, 5 V DC
Expected life	Mechanical life	Min. 2 × 10 <sup>7</sup> (at 180 times/min.)
	Electrical life (Resistive load)	Min. 3 × 10 <sup>4</sup> : 3 A 250V AC Min. 3 × 10 <sup>4</sup> : 3 A 30V DC Min. 10 <sup>5</sup> : 2 A 250V AC Min. 10 <sup>5</sup> : 2 A 30V DC

Note: During 4-point simultaneous operation, the rating per point is also as shown above.

## 2. 4-point Terminal

### 1) Input ratings (per relay)

Rated input voltage	Allowable variation of rated input voltage	Allowable input current
12, 24V DC	12V DC±10%, 24V DC±10%	0.2A

Note: The input voltage value above is the allowable current when no relay is installed. Please note that input voltage is determined by the type of relay installed.

### 2) Input rating when PA-N relay installed (per relay, at 20°C 68°F)

Type	Rated input voltage	Operate voltage (Initial)	Release voltage (Initial)	Input current (during application of rated voltage)
APAN3112	12V DC	Max. 9.5V DC (Relay max. 8.4V + include diode max. 1.1V)	Min. 1.0V DC (Relay min. 0.6V + include diode min. 0.4V)	Approx. 10.7mA (Relay 9.2mA + LED 1.5mA)
APAN3124	24V DC	Max. 17.9V DC (Relay max. 16.8V + include diode max. 1.1V)	Min. 1.6V DC (Relay min. 1.2V + include diode min. 0.4V)	Approx. 7.6mA (Relay 4.6mA + LED 3.0mA)

### 3) Input rating when PhotoMOS Power voltage sensitive type installed (per relay, at 25°C 77°F)

Type	Rated input voltage	Operate voltage (Initial)	Release voltage (Initial)	Input current (during application of rated input voltage)
AQZ*0*D	12, 24V DC	Max. 5.1V DC (Relay max. 4.0V + include diode max. 1.1V)	Min. 1.2V DC (Relay min. 0.8V + include diode min. 0.4V)	Approx. 10.0mA (Relay 7.0mA + LED 3.0mA)

### 4) Output rating (per relay)

Allowable load voltage	Allowable load current
600V (DC), 600V (AC peak value)	3A

Note: The value above is the allowable value when no relay is installed.  
Please note that limitations apply to the load voltage and current depending on the type of relay installed.

### 5) Output rating when PA-N relay installed (per relay, at 20°C 68°F)

Specification	Item	Specifications
Contact data	Contact rating (Resistive load)	3 A 250 V AC, 3 A 30 V DC
	Max. switching power (Resistive load)	750 VA (AC), 90 W (DC)
	Max. switching voltage	250 V AC, 30 V DC
	Max. switching current	3 A
	Min. switching load (Reference value)	1 mA, 5 V DC
Expected life	Mechanical life	Min. 2×10 <sup>7</sup> (at 180 times/min.)
	Electrical life (Resistive load)	Min. 3×10 <sup>4</sup> : 3 A 250V AC, 3 A 30V DC Min. 10 <sup>5</sup> : 2 A 250V AC, 2 A 30V DC

Note: During 4-point simultaneous operation, the rating per point is also as shown above.

### 6) Output rating when PhotoMOS Power voltage sensitive type installed (per relay, at 25°C 77°F)

Possible relays		Maximum load voltage (DC, AC peak value)	Continuous load current (DC, AC peak value)	Possible relays		Maximum load voltage (DC, AC peak value)	Continuous load current (DC, AC peak value)
Type	Part No.			Type	Part No.		
DC only	AQZ102D	60V	1.80A	AC, DC dual use	AQZ202D	60V	1.350A
	AQZ105D	100V	1.15A		AQZ205D	100V	0.900A
	AQZ107D	200V	0.55A		AQZ207D	200V	0.450A
	AQZ104D	400V	0.30A		AQZ204D	400V	0.225A

Notes: 1. During 4-point simultaneous operation, the rating per point is also as shown above.  
2. Please use a load current that is within the range of the data given below in "REFERENCE DATA Load current vs. ambient temperature characteristics".

# SPECIFICATIONS

## RT-3 Unit relay/4-point Terminal

Item		Specifications	Condition
Dielectric strength (Initial)	Between input and output	2,000 Vrms	for 1 min.
	Between different terminals (between relays, both ways)	1,500 Vrms	for 1 min.
Insulation resistance (Initial)		Min. 100 MΩ (Measurement at same location as "Breakdown voltage" section.)	Using 500 V DC megger
Vibration resistance	Destructive	10 to 55 Hz at double amplitude 1 mm .039 inch	In vertical, horizontal and longitudinal directions
	Functional	10 to 55 Hz at double amplitude 1 mm .039 inch	In vertical, horizontal and longitudinal directions
Shock resistance	Destructive	Min. 196 m/s <sup>2</sup>	In vertical, horizontal and longitudinal directions
	Functional	Min. 98 m/s <sup>2</sup>	In vertical, horizontal and longitudinal directions
Condition	Ambient temperature	-20 to +55°C -4 to +131°F	Not freezing and condensing
	Ambient humidity	35 to 85% R.H.	Not condensing
	Storage temperature	-30 to +80°C -22 to +176°F	Not freezing and condensing
Terminal screw fasten torque		0.3 to 0.5 N·m	
Coil surge absorber		Diode (1A, 400V)	
Cross connection protecting diode		1 A, inverse voltage 400 V	
Unit weight		Approx. 100 g 3.53 oz	

- Notes: 1. The value of breakdown voltage and insulation resistance is the initial one.  
 2. Condensing occurs when the unit relay is exposed to sudden temperature change in a high temperature and high humidity atmosphere. This may cause some troubles like insulation failure of the socket or the print circuit board. Take care under this condition.  
 3. Below 0°C 32°F, condensing water can freeze and cause socket contact failures and other problems. Take care under this condition.

# REFERENCE DATA

### 1. Maximum value for switching capacity (output)

Per PA-N relay

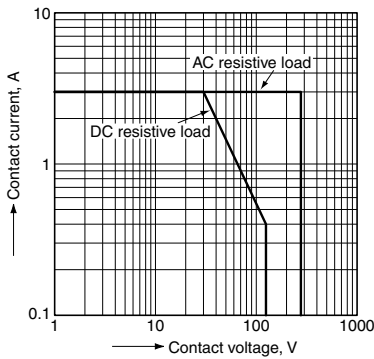

### 2. Load current vs. ambient temperature characteristics (DC only)

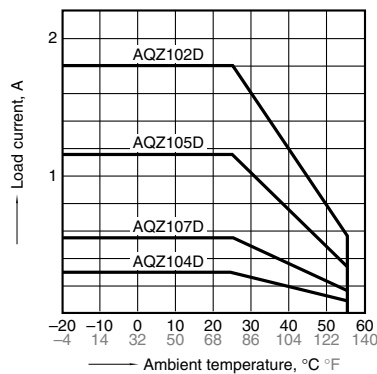

### 3. Load current vs. ambient temperature characteristics (AC/DC dual use)

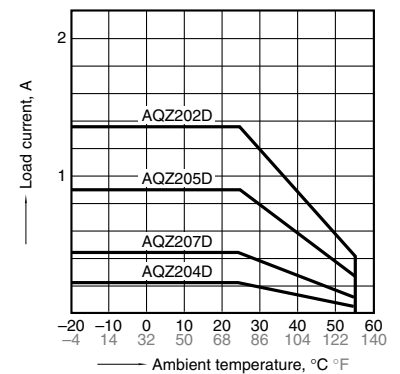

# RT-3 Unit Relay/4-point Terminal (PA-N Relay type)

## DIMENSIONS (mm inch)

### 1. External dimensions

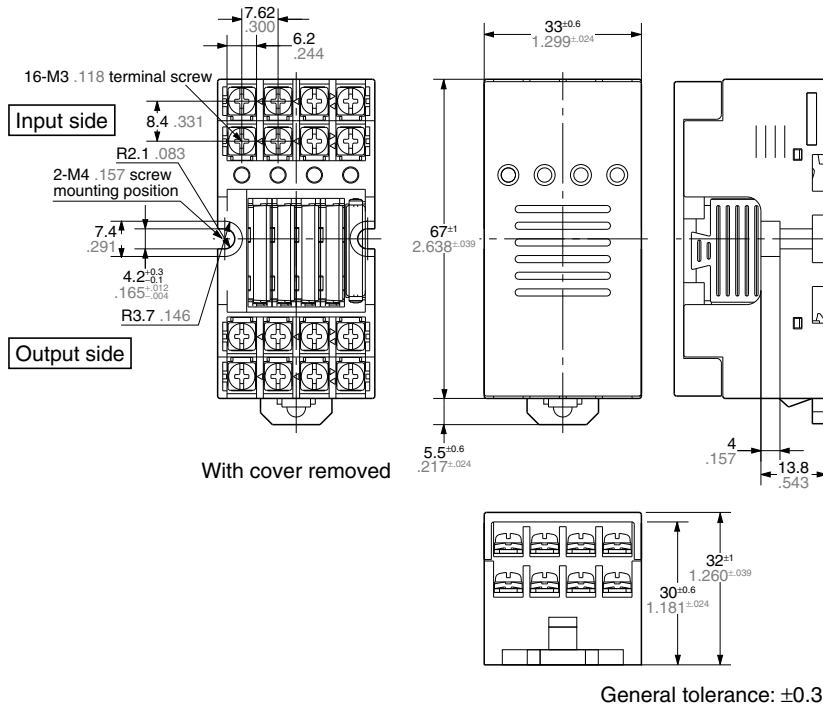

### 2. Schematic

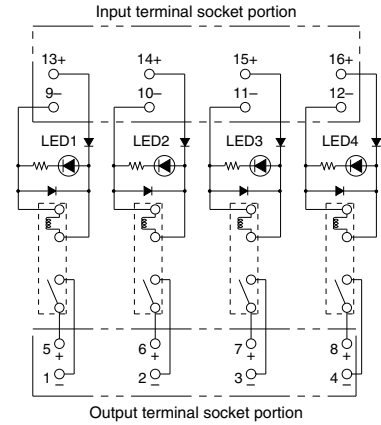

Note: It is PA-N relay type.  
 Cannot be equipped with PhotoMOS Power standard type relays. However, equipping with voltage sensitive type of PhotoMOS Power type is possible.  
 The polarities of the output terminal socket are for the DC only type (equipped with AQZ10\*D)

### 3. Mounting hole pattern

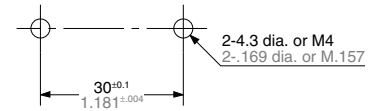

### CAUTIONS FOR USE

### RT-3 UNIT RELAY 4-POINT TERMINAL

1. Never install modules (relays) into this product other than those designated. Doing so will cause malfunction, breakdown, and breakdown of the connected product.
2. If a unit is dropped be sure to check its external appearance and characteristics before using it.
3. The operation and return voltage values when equipped with PA-N relays are based on the relay terminals being face down. (RT-3 Unit relay (PA-N type), 4-point Terminal)
4. Switching lifetime (PA-N relay)

This characteristic depends on the relay and is effected by coil driving circuit, load type, activation frequency, activation phase, ambient conditions and other factors.

Also, be especially careful of loads such as those listed below.

- 1) When used for AC load-operating and the operating phase is synchronous, rocking and fusing can easily occur due to contact shifting.

- 2) Frequent switching under load condition

When high frequently switched under load condition that can cause arc at the contacts, nitrogen and oxygen in the air is fused by the arc energy and  $\text{HNO}_3$  is formed. This can corrode metal materials. Three countermeasures for these are listed here.

- (1) Incorporate an arc-extinguishing circuit.
- (2) Lower the operating frequency
- (3) Lower the ambient humidity

#### 5. Operating environment

- 1) Keep the product as far way as possible from power cables, high tension equipment, power equipment, equipment with transmitting devices such as amateur radios, or equipment which generates a large switching surge.
- 2) The main unit is made of resin; therefore, do not use it in areas where it may come in contact with (or be exposed to) organic solvents such as gasoline, thinner, and alcohol, or strong alkaline substances such as ammonia and caustic soda.
- 3) Do not use the product in areas where it may be exposed to flammable gases, corrosive gases, excessive dust, or

moisture, or areas where it may be subjected to strong vibration or shock.

#### 6. Installing and removing the module

- 1) Firmly insert the module into the socket with the terminals going in the direction of the blade receptacles.
- 2) The module can be easily removed using the removal key.
  - (1) Insert the removal key into the socket slots.

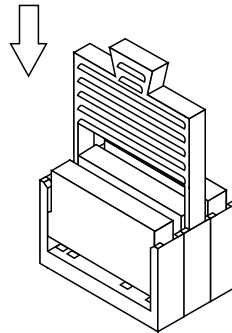

- (2) Pull the removal key up to remove the module.

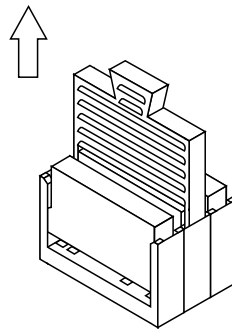

- (3) Slide the removal key off of the module.

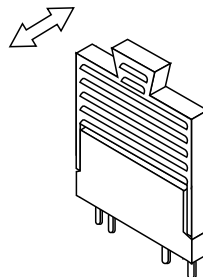

#### 7. Wiring and circuit configuration

- 1) Perform wiring according to the internal schematic. Take care not to make any mistakes. In particular, with the RT-3 Unit relay (PA-N relay type) and 4-point terminal, be careful of the polarity on the output side

when equipped with AQZ10\*D (DC type). Also, with the RT-3 Unit relay (PhotoMOS Power type), be careful of the polarity on the output side of the DC type (RT3SP1-\*\*V for type equipped with AQZ102).

- 2) We recommend the use of wire-pressed terminals for connection to the terminal portion.

• Example of applicable wire-pressed terminal

Company Name	Part Name	Applicable wire-pressed terminal
J.S.T. Mfg Co., Ltd.	1.25 to C3A	0.25 to 1.65mm <sup>2</sup>

- 3) When the load is inductive, limit spike voltages generated from the load to less than the maximum load voltage. Typical circuits are shown below.

- (1) Add a clamp diode to the load.

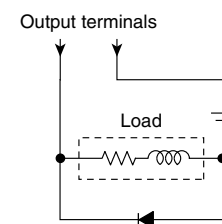

- (2) Add an R-C snubber to the load.

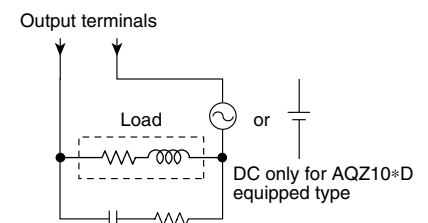

- (3) Add a varistor between the output terminals.

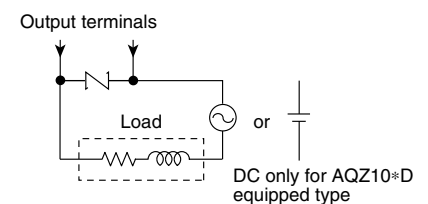

- 4) Even if spike voltages generated from the load are limited by a clamp diode or R-C snubber, inductances in long circuit wires will still create spike voltages. Keep wires as short as possible to minimize inductance.

# CAUTIONS FOR USE

## 8. Installation

- 1) Perform mounting hole cutout according to the panel cutout drawings.
- 2) When installing the unit on a DIN rail, use the DIN rail locking lever on the side of the unit. Installation is accomplished by simply fitting the unit onto the rail and pressing gently.

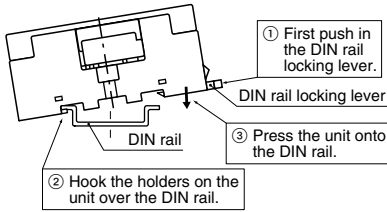

- 3) To remove the unit from the DIN rail, use a flat head screwdriver to pull out the DIN rail locking lever.

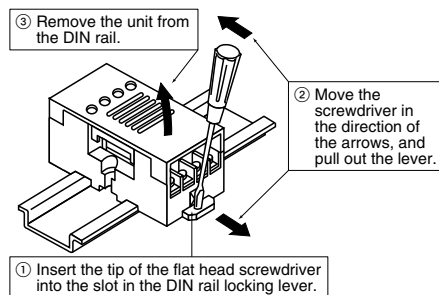

## 9. Transporting and storage

- 1) If the product is subjected to extreme vibration while being transported, the relays may become detached, the lead may become bent, and the unit may become damaged. Handle the carton and case with care.
- 2) If the product is stored in an extremely adverse environment, visible defects and deterioration of performance characteristics may result. We recommend the following storage conditions.
  - Temperature: 5 to 30°C 41 to 86°F
  - Humidity: Max. 60% R.H.
  - Environment: No hazardous substances such as sulfurous acid gases and little dust.

## 10. When equipped with PhotoMOS Power voltage drive type [RT-3 Unit relay (PA-N relay type), 4-point Terminal]

Since the PhotoMOS Power voltage sensitive type does not require the current-controlling resistance on the input side, it can be used together with PA-N relays on RT-3 unit relay (PA-N relay type).

When connecting PhotoMOS Power voltage sensitive types, since it will be a close connection, it will be necessary to be careful of load currents. Be sure to refer to the information given regarding "Load currents vs ambient temperature characteristics" in the precautions given for use of 4-point terminals.

## TERMINAL BLOCK

We recommend using wire-pressed terminals for connection to the terminal portion.

- Applicable electrical wire: 0.25 to 1.65 mm<sup>2</sup> .01 to .065 inch
- Applicable wire-pressed terminals (mm inch)

Company Name	Part Name	Part Name
J.S.T. Mfg Co., Ltd.	1.25 to C3A	1.25 to 3
NICHIFU	1.25Y to 3N	1.25 to 3
Nippon Tanshi Co., Ltd.	VD1.25 to 3L	R1.25 to 3

## ACCESSORIES

### Short circuit plate for RT-3 Unit relay

Use when you want to bridge terminals.

< With insulator >

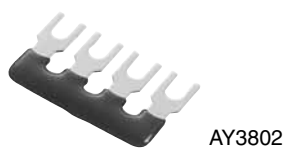

AY3802

External dimensions (mm inch)

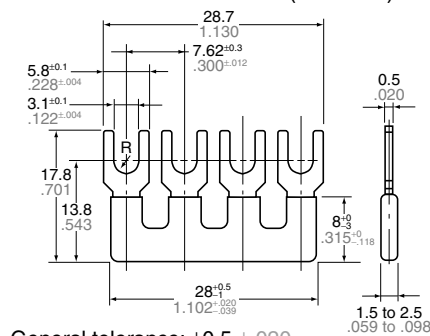

< Without insulator >



AY3803

External dimensions (mm inch)

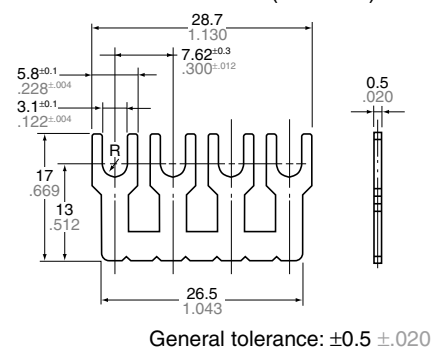

---

Please contact .....

**Panasonic Corporation**

Electromechanical Control Business Division

■ 1006, Oaza Kadoma, Kadoma-shi, Osaka 571-8506, Japan  
[industrial.panasonic.com/ac/e/](http://industrial.panasonic.com/ac/e/)

**Panasonic**<sup>®</sup>

©Panasonic Corporation 2017

# Mouser Electronics

Authorized Distributor

Click to View Pricing, Inventory, Delivery & Lifecycle Information:

[Panasonic:](#)

[RT3SN-12V](#) [RT3SN-24V](#)