

# EFR32MG21 Mighty Gecko Multiprotocol Wireless SoC Family Data Sheet



The Mighty Gecko multiprotocol family of SoCs is part of the Wireless Gecko portfolio. Mighty Gecko SoCs are ideal for enabling energy-friendly multiprotocol, multiband networking for IoT devices.

The single-die solution combines an 80 MHz ARM Cortex-M33 with a high performance 2.4 GHz radio to provide an industry-leading, energy efficient wireless SoC for IoT connected applications.

Mighty Gecko applications include:

- IoT Multi-Protocol Devices
- Lighting
- Connected Home
- Gateways and Digital Assistants
- Building Automation and Security

## KEY FEATURES

- 32-bit ARM® Cortex®-M33 core with 80 MHz maximum operating frequency
- Up to 1024 kB of flash and 96 kB of RAM
- 12-channel Peripheral Reflex System enabling autonomous interaction of MCU peripherals
- Integrated PA with up to 20 dBm (2.4 GHz) TX power
- Robust peripheral set and up to 20 GPIO in a 4x4 QFN package

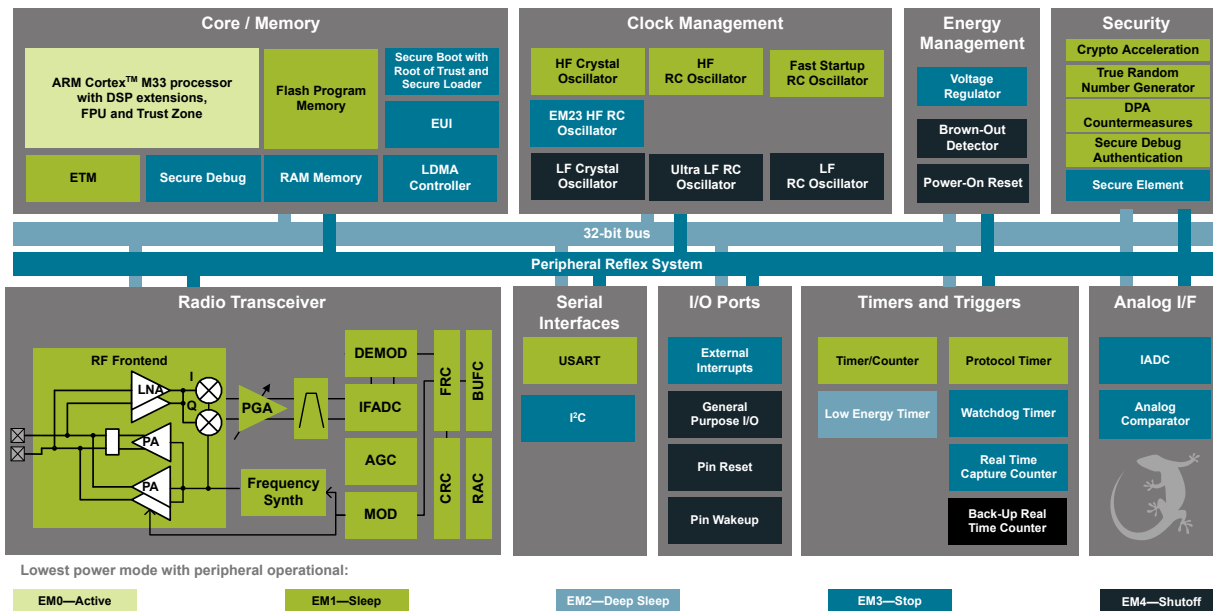

## 1. Feature List

The EFR32MG21 highlighted features are listed below.

- **Low Power Wireless System-on-Chip**
  - High Performance 32-bit 80 MHz ARM Cortex<sup>®</sup>-M33 with DSP instruction and floating-point unit for efficient signal processing
  - Up to 1024 kB flash program memory
  - Up to 96 kB RAM data memory
  - 2.4 GHz radio operation
  - TX power up to 20 dBm
- **Low Energy Consumption**
  - 8.8 mA RX current at 2.4 GHz (1 Mbps GFSK)
  - 9.4 mA RX current at 2.4 GHz (250 kbps O-QPSK DSSS)
  - 9.3 mA TX current @ 0 dBm output power at 2.4 GHz
  - 33.8 mA TX current @ 10 dBm output power at 2.4 GHz
  - 50.9  $\mu$ A/MHz in Active Mode (EM0)
  - 5.0  $\mu$ A EM2 DeepSleep current
    - (96 kB RAM retention and RTC running from LFXO)
  - 4.5  $\mu$ A EM2 DeepSleep current
    - (16 kB RAM retention and RTC running from LFRCO)
- **High Receiver Performance**
  - -104.5 dBm sensitivity @ 250 kbps O-QPSK DSSS
  - -97.5 dBm sensitivity @ 1 Mbit/s GFSK
  - -94.4 dBm sensitivity @ 2 Mbit/s GFSK
  - -104.9 dBm sensitivity @ 125 kbps GFSK
- **Supported Modulation Formats**
  - GFSK
  - OQPSK
- **Protocol Support**
  - Bluetooth Low Energy (Bluetooth 5)
  - Zigbee
  - Thread
- **Wide selection of MCU peripherals**
  - 12-bit 1 Msps SAR Analog to Digital Converter (ADC)
  - 2  $\times$  Analog Comparator (ACMP)
  - Up to 20 General Purpose I/O pins with output state retention and asynchronous interrupts
  - 8 Channel DMA Controller
  - 12 Channel Peripheral Reflex System (PRS)
  - 2  $\times$  16-bit Timer/Counter
    - 3 Compare/Capture/PWM channels
  - 1  $\times$  32-bit Timer/Counter
    - 3 Compare/Capture/PWM channels
  - 32-bit Real Time Counter
  - 24-bit Low Energy Timer for waveform generation
  - 2  $\times$  Watchdog Timer
  - 3  $\times$  Universal Synchronous/Asynchronous Receiver/Transmitter (UART/SPI/SmartCard(ISO 7816)/IrDA/I<sup>2</sup>S)
  - 2  $\times$  I<sup>2</sup>C interface with SMBus support
- **Wide Operating Range**
  - 1.71 to 3.8 V single power supply
  - -40 to 125  $^{\circ}$ C ambient
- **Security**
  - Secure Boot with Root of Trust and Secure Loader (RTSL)
  - Hardware Cryptographic Acceleration with DPA countermeasures for AES128/256, SHA-1, SHA-2 (up to 256-bit), ECC (up to 256-bit), ECDSA, ECDH and J-Pake
  - True Random Number Generator (TRNG) compliant with NIST SP800-90 and AIS-31
  - ARM<sup>®</sup> TrustZone<sup>®</sup>
  - Secure Debug with lock/unlock
- **QFN32 4x4 mm Package**
  - 0.4 mm pitch

## 2. Ordering Information

**Table 2.1. Ordering Information**

Ordering Code	Protocol Stack	Max TX Power @ Frequency Band	Flash (kB)	RAM (kB)	Security	GPIO	Package
EFR32MG21A010F1024IM32-B	<ul style="list-style-type: none"> <li>• Bluetooth 5.1</li> <li>• Zigbee</li> <li>• Thread</li> </ul>	10 dBm @ 2.4 GHz	1024	96	Secure Element	20	QFN32
EFR32MG21A010F512IM32-B	<ul style="list-style-type: none"> <li>• Bluetooth 5.1</li> <li>• Zigbee</li> <li>• Thread</li> </ul>	10 dBm @ 2.4 GHz	512	64	Secure Element	20	QFN32
EFR32MG21A010F768IM32-B	<ul style="list-style-type: none"> <li>• Bluetooth 5.1</li> <li>• Zigbee</li> <li>• Thread</li> </ul>	10 dBm @ 2.4 GHz	768	64	Secure Element	20	QFN32
EFR32MG21A020F1024IM32-B	<ul style="list-style-type: none"> <li>• Bluetooth 5.1</li> <li>• Zigbee</li> <li>• Thread</li> </ul>	20 dBm @ 2.4 GHz	1024	96	Secure Element	20	QFN32
EFR32MG21A020F512IM32-B	<ul style="list-style-type: none"> <li>• Bluetooth 5.1</li> <li>• Zigbee</li> <li>• Thread</li> </ul>	20 dBm @ 2.4 GHz	512	64	Secure Element	20	QFN32
EFR32MG21A020F768IM32-B	<ul style="list-style-type: none"> <li>• Bluetooth 5.1</li> <li>• Zigbee</li> <li>• Thread</li> </ul>	20 dBm @ 2.4 GHz	768	64	Secure Element	20	QFN32

# Table of Contents

<b>1. Feature List</b>	<b>2</b>
<b>2. Ordering Information</b>	<b>3</b>
<b>3. System Overview</b>	<b>6</b>
3.1 Introduction	6
3.2 Radio	6
3.2.1 Antenna Interface	6
3.2.2 Fractional-N Frequency Synthesizer	7
3.2.3 Receiver Architecture	7
3.2.4 Transmitter Architecture	7
3.2.5 Packet and State Trace	7
3.2.6 Data Buffering	7
3.2.7 Radio Controller (RAC)	7
3.3 General Purpose Input/Output (GPIO)	8
3.4 Clocking	8
3.4.1 Clock Management Unit (CMU)	8
3.4.2 Internal and External Oscillators	8
3.5 Counters/Timers and PWM	8
3.5.1 Timer/Counter (TIMER)	8
3.5.2 Low Energy Timer (LETIMER)	8
3.5.3 Real Time Clock with Capture (RTCC)	9
3.5.4 Back-Up Real Time Counter	9
3.5.5 Watchdog Timer (WDOG)	9
3.6 Communications and Other Digital Peripherals	9
3.6.1 Universal Synchronous/Asynchronous Receiver/Transmitter (USART)	9
3.6.2 Inter-Integrated Circuit Interface (I <sup>2</sup> C)	9
3.6.3 Peripheral Reflex System (PRS)	9
3.7 Security Features	9
3.7.1 Secure Boot with Root of Trust and Secure Loader (RTSL)	10
3.7.2 Cryptographic Accelerator	10
3.7.3 True Random Number Generator	10
3.7.4 Secure Debug with Lock/Unlock	10
3.8 Analog	10
3.8.1 Analog Comparator (ACMP)	10
3.8.2 Analog to Digital Converter (IADC)	11
3.9 Reset Management Unit (RMU)	11
3.10 Core and Memory	11
3.10.1 Processor Core	11
3.10.2 Memory System Controller (MSC)	11
3.10.3 Linked Direct Memory Access Controller (LDMA)	11
3.11 Memory Map	12
3.12 Configuration Summary	13

<b>4. Electrical Specifications</b>	<b>14</b>
4.1 Electrical Characteristics	.14
4.1.1 Absolute Maximum Ratings	.14
4.1.2 General Operating Conditions	.15
4.1.3 Thermal Characteristics	.16
4.1.4 Current Consumption	.17
4.1.5 2.4 GHz RF Transceiver Characteristics	.22
4.1.6 Flash Characteristics	.37
4.1.7 Wake Up, Entry, and Exit times	.38
4.1.8 Oscillators	.39
4.1.9 GPIO Pins (3V GPIO pins)	.44
4.1.10 Analog to Digital Converter (ADC)	.45
4.1.11 Analog Comparator (ACMP)	.47
4.1.12 Temperature Sense	.48
4.1.13 Brown Out Detectors	.49
4.1.14 SPI Electrical Specifications	.51
4.1.15 I2C Electrical Specifications.	.52
4.2 Typical Performance Curves	.54
4.2.1 Supply Current	.55
4.2.2 2.4 GHz Radio	.57
<b>5. Typical Connection Diagrams</b>	<b>60</b>
5.1 Power	.60
5.2 RF Matching Networks	.60
5.2.1 2.4 GHz 0 dBm Matching Network	.60
5.2.2 2.4 GHz 10 dBm Matching Network	.61
5.2.3 2.4 GHz 20 dBm Matching Network	.62
5.3 Other Connections.	.62
<b>6. Pin Definitions</b>	<b>63</b>
6.1 QFN32 2.4GHz Device Pinout	.63
6.2 Alternate Function Table.	.64
6.3 Analog Peripheral Connectivity	.65
6.4 Digital Peripheral Connectivity	.66
<b>7. QFN32 Package Specifications.</b>	<b>69</b>
7.1 QFN32 Package Dimensions	.69
7.2 QFN32 PCB Land Pattern	.71
7.3 QFN32 Package Marking	.73
<b>8. Revision History</b>	<b>74</b>

### 3. System Overview

#### 3.1 Introduction

The EFR32 product family combines an energy-friendly MCU with a high performance radio transceiver. The devices are well suited for secure connected IoT multiprotocol devices requiring high performance and low energy consumption. This section gives a short introduction to the full radio and MCU system. The detailed functional description can be found in the EFR32xG21 Reference Manual.

A block diagram of the EFR32MG21 family is shown in [Figure 3.1 Detailed EFR32MG21 Block Diagram on page 6](#). The diagram shows a superset of features available on the family, which vary by OPN. For more information about specific device features, consult [Ordering Information](#).

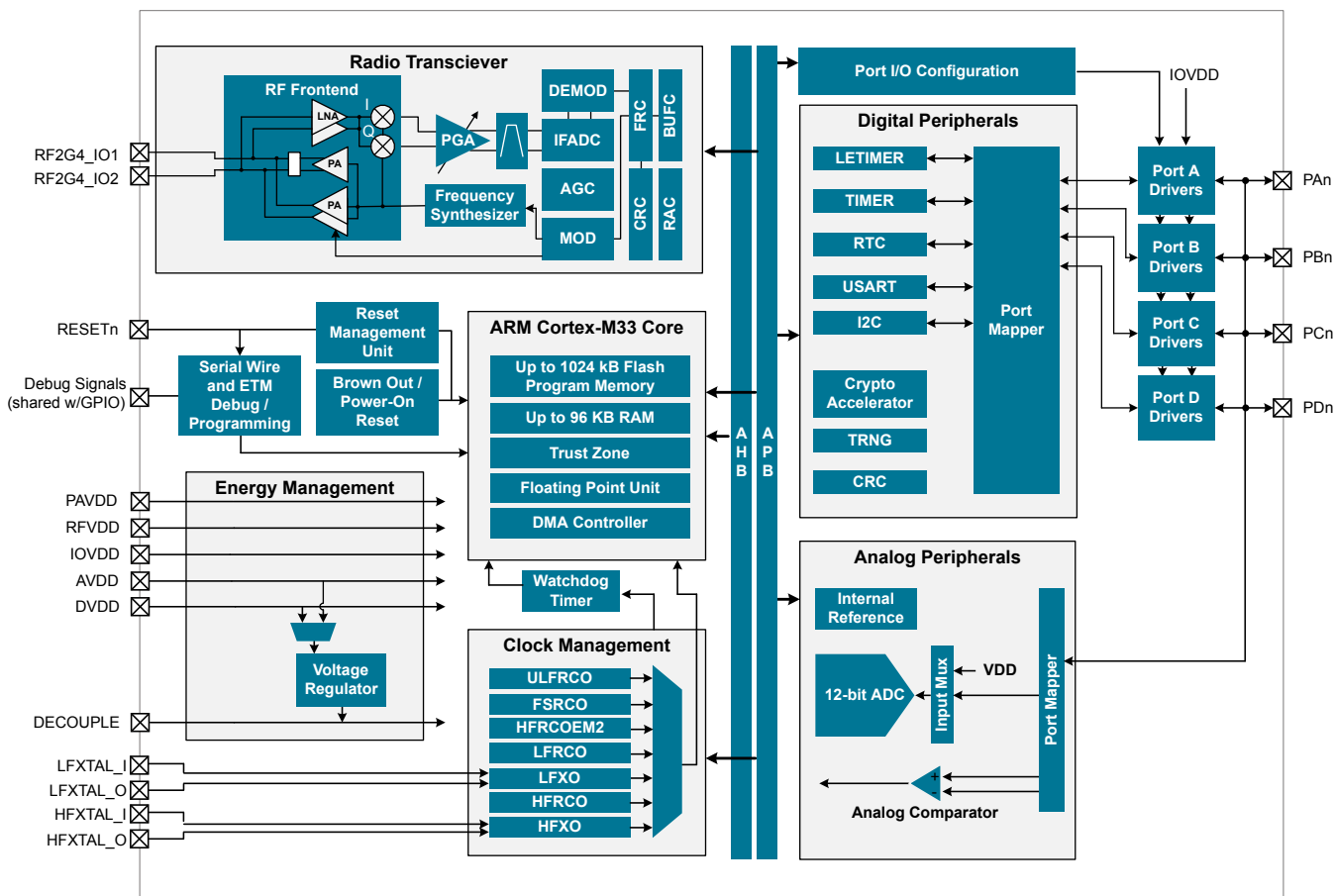

Figure 3.1. Detailed EFR32MG21 Block Diagram

#### 3.2 Radio

The EFR32MG21 Mighty Gecko features a highly configurable radio transceiver supporting Zigbee, Thread, and Bluetooth Low Energy wireless protocols.

##### 3.2.1 Antenna Interface

The 2.4 GHz antenna interface consists of two single-ended pins (RF2G4\_IO1 and RF2G4\_IO2) that interface directly to two LNAs and two 10 dBm PAs. For devices that support 20 dBm, these pins also interface to the 20 dBm on-chip balun. Integrated switches select either RF2G4\_IO1 or RF2G4\_IO2 to be the active path.

The external components and power supply connections for the antenna interface typical applications are shown in the RF Matching Networks section.

### 3.2.2 Fractional-N Frequency Synthesizer

The EFR32MG21 contains a high performance, low phase noise, fully integrated fractional-N frequency synthesizer. The synthesizer is used in receive mode to generate the LO frequency for the down-conversion mixer. It is also used in transmit mode to directly generate the modulated RF carrier.

The fractional-N architecture provides excellent phase noise performance, frequency resolution better than 100 Hz, and low energy consumption. The synthesizer's fast frequency settling allows for very short receiver and transmitter wake up times to reduce system energy consumption.

### 3.2.3 Receiver Architecture

The EFR32MG21 uses a low-IF receiver architecture, consisting of a Low-Noise Amplifier (LNA) followed by an I/Q down-conversion mixer. The I/Q signals are further filtered and amplified before being sampled by the IF analog-to-digital converter (IFADC).

The IF frequency is configurable from 150 kHz to 1371 kHz. The IF can further be configured for high-side or low-side injection, providing flexibility with respect to known interferers at the image frequency.

The Automatic Gain Control (AGC) module adjusts the receiver gain to optimize performance and avoid saturation for excellent selectivity and blocking performance. The 2.4 GHz radio is calibrated at production to improve image rejection performance.

Demodulation is performed in the digital domain. The demodulator performs configurable decimation and channel filtering to allow receive bandwidths ranging from 0.1 to 2530 kHz. High carrier frequency and baud rate offsets are tolerated by active estimation and compensation. Advanced features supporting high quality communication under adverse conditions include forward error correction by block and convolutional coding as well as Direct Sequence Spread Spectrum (DSSS).

A Received Signal Strength Indicator (RSSI) is available for signal quality metrics, for level-based proximity detection, and for RF channel access by Collision Avoidance (CA) or Listen Before Talk (LBT) algorithms. An RSSI capture value is associated with each received frame and the dynamic RSSI measurement can be monitored throughout reception.

### 3.2.4 Transmitter Architecture

The EFR32MG21 uses a direct-conversion transmitter architecture. For constant envelope modulation formats, the modulator controls phase and frequency modulation in the frequency synthesizer. Transmit symbols or chips are optionally shaped by a digital shaping filter. The shaping filter is fully configurable, including the BT product, and can be used to implement Gaussian or Raised Cosine shaping.

Carrier Sense Multiple Access - Collision Avoidance (CSMA-CA) or Listen Before Talk (LBT) algorithms can be automatically timed by the EFR32MG21. These algorithms are typically defined by regulatory standards to improve inter-operability in a given bandwidth between devices that otherwise lack synchronized RF channel access.

### 3.2.5 Packet and State Trace

The EFR32MG21 Frame Controller has a packet and state trace unit that provides valuable information during the development phase. It features:

- Non-intrusive trace of transmit data, receive data and state information
- Data observability on a single-pin UART data output, or on a two-pin SPI data output
- Configurable data output bitrate / baudrate
- Multiplexed transmitted data, received data and state / meta information in a single serial data stream

### 3.2.6 Data Buffering

The EFR32MG21 features an advanced Radio Buffer Controller (BUFC) capable of handling up to 4 buffers of adjustable size from 64 bytes to 4096 bytes. Each buffer can be used for RX, TX or both. The buffer data is located in RAM, enabling zero-copy operations.

### 3.2.7 Radio Controller (RAC)

The Radio Controller controls the top level state of the radio subsystem in the EFR32MG21. It performs the following tasks:

- Precisely-timed control of enabling and disabling of the receiver and transmitter circuitry
- Run-time calibration of receiver, transmitter and frequency synthesizer
- Detailed frame transmission timing, including optional LBT or CSMA-CA

### 3.3 General Purpose Input/Output (GPIO)

EFR32MG21 has up to 20 General Purpose Input/Output pins. Each GPIO pin can be individually configured as either an output or input. More advanced configurations including open-drain, open-source, and glitch-filtering can be configured for each individual GPIO pin. The GPIO pins can be overridden by peripheral connections, like SPI communication. Each peripheral connection can be routed to several GPIO pins on the device. The input value of a GPIO pin can be routed through the Peripheral Reflex System to other peripherals. The GPIO subsystem supports asynchronous external pin interrupts.

All of the pins on ports A and port B are EM2 capable. These pins may be used by Low-Energy peripherals in EM2/3 and may also be used as EM2/3 pin wake-ups. Pins on ports C and D are latched/retained in their current state when entering EM2 until EM2 exit upon which internal peripherals could once again drive those pads.

A few GPIOs also have EM4 wake functionality. These pins are listed in [6.2 Alternate Function Table](#).

### 3.4 Clocking

#### 3.4.1 Clock Management Unit (CMU)

The Clock Management Unit controls oscillators and clocks in the EFR32MG21. Individual enabling and disabling of clocks to all peripheral modules is performed by the CMU. The CMU also controls enabling and configuration of the oscillators. A high degree of flexibility allows software to optimize energy consumption in any specific application by minimizing power dissipation in unused peripherals and oscillators.

#### 3.4.2 Internal and External Oscillators

The EFR32MG21 supports two crystal oscillators and fully integrates five RC oscillators, listed below.

- A high frequency crystal oscillator (HFXO) with integrated load capacitors, tunable in small steps, provides a precise timing reference for the MCU and RF synthesizer. The HFXO provides excellent RF clocking performance using a 38.4 MHz crystal. The HFXO can also support an external clock source such as a TCXO for applications that require an extremely accurate clock frequency over temperature.
- A 32.768 kHz crystal oscillator (LFXO) provides an accurate timing reference for low energy modes.
- An integrated high frequency RC oscillator (HFRCO) is available for the MCU system, when crystal accuracy is not required. The HFRCO employs fast start-up at minimal energy consumption combined with a wide frequency range, from 1 MHz to 80 MHz.
- An integrated high frequency RC oscillator (HFRCOEM2) runs down to EM2 and is available for timing the general-purpose ADC and the Serial Wire Viewer port with a wide frequency range.
- An integrated fast start-up RC oscillator (FSRRCO) that runs at a fixed 20 MHz
- An integrated low frequency 32.768 kHz RC oscillator (LFRCO) for low power operation where high accuracy is not required.
- An integrated ultra-low frequency 1 kHz RC oscillator (ULFRCO) is available to provide a timing reference at the lowest energy consumption in low energy modes.

### 3.5 Counters/Timers and PWM

#### 3.5.1 Timer/Counter (TIMER)

TIMER peripherals keep track of timing, count events, generate PWM outputs and trigger timed actions in other peripherals through the Peripheral Reflex System (PRS). The core of each TIMER is a 16-bit or 32-bit counter with up to 3 compare/capture channels. Each channel is configurable in one of three modes. In capture mode, the counter state is stored in a buffer at a selected input event. In compare mode, the channel output reflects the comparison of the counter to a programmed threshold value. In PWM mode, the TIMER supports generation of pulse-width modulation (PWM) outputs of arbitrary waveforms defined by the sequence of values written to the compare registers. In addition some timers offer dead-time insertion.

See [3.12 Configuration Summary](#) for information on the feature set of each timer.

#### 3.5.2 Low Energy Timer (LETIMER)

The unique LETIMER is a 24-bit timer that is available in energy mode EM2 Deep Sleep in addition to EM1 Sleep and EM0 Active. This allows it to be used for timing and output generation when most of the device is powered down, allowing simple tasks to be performed while the power consumption of the system is kept at an absolute minimum. The LETIMER can be used to output a variety of waveforms with minimal software intervention. The LETIMER is connected to the Peripheral Reflex System (PRS), and can be configured to start counting on compare matches from other peripherals such as the RTCC.



### 3.5.3 Real Time Clock with Capture (RTCC)

The Real Time Clock with Capture (RTCC) is a 32-bit counter providing timekeeping down to EM3. The RTCC can be clocked by any of the on-board low-frequency oscillators, and it is capable of providing system wake-up at user defined intervals.

A secondary RTC is used by the RF protocol stack for event scheduling, leaving the primary RTCC block available exclusively for application software.

### 3.5.4 Back-Up Real Time Counter

The Back-Up Real Time Counter (BURTC) is a 32-bit counter providing timekeeping in all energy modes, including EM4. The BURTC can be clocked by any of the on-board low-frequency oscillators, and it is capable of providing system wake-up at user defined intervals.

### 3.5.5 Watchdog Timer (WDOG)

The watchdog timer can act both as an independent watchdog or as a watchdog synchronous with the CPU clock. It has windowed monitoring capabilities, and can generate a reset or different interrupts depending on the failure mode of the system. The watchdog can also monitor autonomous systems driven by the Peripheral Reflex System (PRS).

## 3.6 Communications and Other Digital Peripherals

### 3.6.1 Universal Synchronous/Asynchronous Receiver/Transmitter (USART)

The Universal Synchronous/Asynchronous Receiver/Transmitter is a flexible serial I/O module. It supports full duplex asynchronous UART communication with hardware flow control as well as RS-485, SPI, MicroWire and 3-wire. It can also interface with devices supporting:

- ISO7816 SmartCards
- IrDA
- I<sup>2</sup>S

### 3.6.2 Inter-Integrated Circuit Interface (I<sup>2</sup>C)

The I<sup>2</sup>C module provides an interface between the MCU and a serial I<sup>2</sup>C bus. It is capable of acting as both a master and a slave and supports multi-master buses. Standard-mode, fast-mode and fast-mode plus speeds are supported, allowing transmission rates from 10 kbit/s up to 1 Mbit/s. Slave arbitration and timeouts are also available, allowing implementation of an SMBus-compliant system. The interface provided to software by the I<sup>2</sup>C module allows precise timing control of the transmission process and highly automated transfers. Automatic recognition of slave addresses is provided in active and low energy modes. Note that not all instances of I<sup>2</sup>C are available in all energy modes.

### 3.6.3 Peripheral Reflex System (PRS)

The Peripheral Reflex System provides a communication network between different peripheral modules without software involvement. Peripheral modules producing Reflex signals are called producers. The PRS routes Reflex signals from producers to consumer peripherals which in turn perform actions in response. Edge triggers and other functionality such as simple logic operations (AND, OR, NOT) can be applied by the PRS to the signals. The PRS allows peripherals to act autonomously without waking the MCU core, saving power.

## 3.7 Security Features

A dedicated security CPU enables the Secure Element function. It isolates cryptographic functions and data from the host Cortex-M33 core and provides the following security features:

- Secure Boot with Root of Trust and Secure Loader (RTSL)
- Cryptographic Accelerator
- True Random Number Generator (TRNG)
- Secure Debug with Lock/Unlock

### 3.7.1 Secure Boot with Root of Trust and Secure Loader (RTSL)

The Secure Boot with RTSL authenticates a chain of trusted firmware that begins from an immutable memory (ROM).

It prevents malware injection, prevents rollback, ensures that only authentic firmware is executed and protects Over The Air updates.

More information on this feature can be found in the Application Note *AN1218: Series 2 Secure Boot with RTSL*.

### 3.7.2 Cryptographic Accelerator

The Cryptographic Accelerator is an autonomous hardware accelerator with Differential Power Analysis (DPA) countermeasures to protect keys.

It supports AES encryption and decryption with 128/192/256-bit keys, Elliptic Curve Cryptography(ECC) to support public key operations and hashes.

Supported block cipher modes of operation for AES include:

- ECB (Electronic Code Book)
- CTR (Counter Mode)
- CBC (Cipher Block Chaining)
- CFB (Cipher Feedback)
- GCM (Galois Counter Mode)
- CBC-MAC (Cipher Block Chaining Message Authentication Code)
- GMAC (Galois Message Authentication Code)
- CCM (Counter with CBC-MAC)

The Cryptographic Accelerator accelerates Elliptical Curve Cryptography and supports the NIST (National Institute of Standards and Technology) recommended curves including P-192 and P-256 for ECDH(Elliptic Curve Diffie-Hellman) key derivation and ECDSA (Elliptic Curve Digital Signature Algorithm) sign and verify operations.

Supported hashes include SHA-1, SHA2/224, and SHA-2/256.

This implementation provides a fast and energy efficient solution to state of the art cryptographic needs.

### 3.7.3 True Random Number Generator

The True Random Number Generator module is a non-deterministic random number generator that harvests entropy from a thermal energy source. It includes start-up health tests for the entropy source as required by NIST SP800-90B and AIS-31 as well as online health tests required for NIST SP800-90C.

The TRNG is suitable for periodically generating entropy to seed an approved pseudo random number generator.

### 3.7.4 Secure Debug with Lock/Unlock

For obvious security reasons, it is critical for a product to have its debug interface locked before being released in the field.

In addition, the Secure Element also provides a secure debug unlock function that allows authenticated access based on public key cryptography. This functionality is particularly useful for supporting failure analysis while maintaining confidentiality of IP and sensitive end-user data.

More information on this feature can be found in the Application Note *AN1190: EFR32xG21 Secure Debug*.

## 3.8 Analog

### 3.8.1 Analog Comparator (ACMP)

The Analog Comparator is used to compare the voltage of two analog inputs, with a digital output indicating which input voltage is higher. Inputs are selected from among internal references and external pins. The tradeoff between response time and current consumption is configurable by software. Two 6-bit reference dividers allow for a wide range of internally-programmable reference sources. The ACMP can also be used to monitor the supply voltage. An interrupt can be generated when the supply falls below or rises above the programmable threshold.

### 3.8.2 Analog to Digital Converter (IADC)

The IADC is a hybrid architecture combining techniques from both SAR and Delta-Sigma style converters. It has a resolution of up to 12 bits at up to 1 Msps. Hardware oversampling reduces system-level noise over multiple front-end samples. The IADC includes integrated voltage references. Inputs are selectable from a wide range of sources, including pins configurable as either single-ended or differential.

### 3.9 Reset Management Unit (RMU)

The RMU is responsible for handling reset of the EFR32MG21. A wide range of reset sources are available, including several power supply monitors, pin reset, software controlled reset, core lockup reset, and watchdog reset.

### 3.10 Core and Memory

#### 3.10.1 Processor Core

The ARM Cortex-M processor includes a 32-bit RISC processor integrating the following features and tasks in the system:

- ARM Cortex-M33 RISC processor achieving 1.50 Dhrystone MIPS/MHz
- ARM TrustZone security technology
- Embedded Trace Macrocell (ETM) for real-time trace and debug
- Up to 1024 kB flash program memory
- Up to 96 kB RAM data memory
- Configuration and event handling of all modules
- 2-pin Serial-Wire debug interface

#### 3.10.2 Memory System Controller (MSC)

The Memory System Controller (MSC) is the program memory unit of the microcontroller. The flash memory is readable and writable from both the Cortex-M and DMA. In addition to the main flash array where Program code is normally written the MSC also provides an Information block where additional information such as special user information or flash-lock bits are stored. There is also a read-only page in the information block containing system and device calibration data. Read and write operations are supported in energy modes EM0 Active and EM1 Sleep.

#### 3.10.3 Linked Direct Memory Access Controller (LDMA)

The Linked Direct Memory Access (LDMA) controller allows the system to perform memory operations independently of software. This reduces both energy consumption and software workload. The LDMA allows operations to be linked together and staged, enabling sophisticated operations to be implemented.

### 3.11 Memory Map

The EFR32MG21 memory map is shown in the figures below. RAM and flash sizes are for the largest memory configuration.

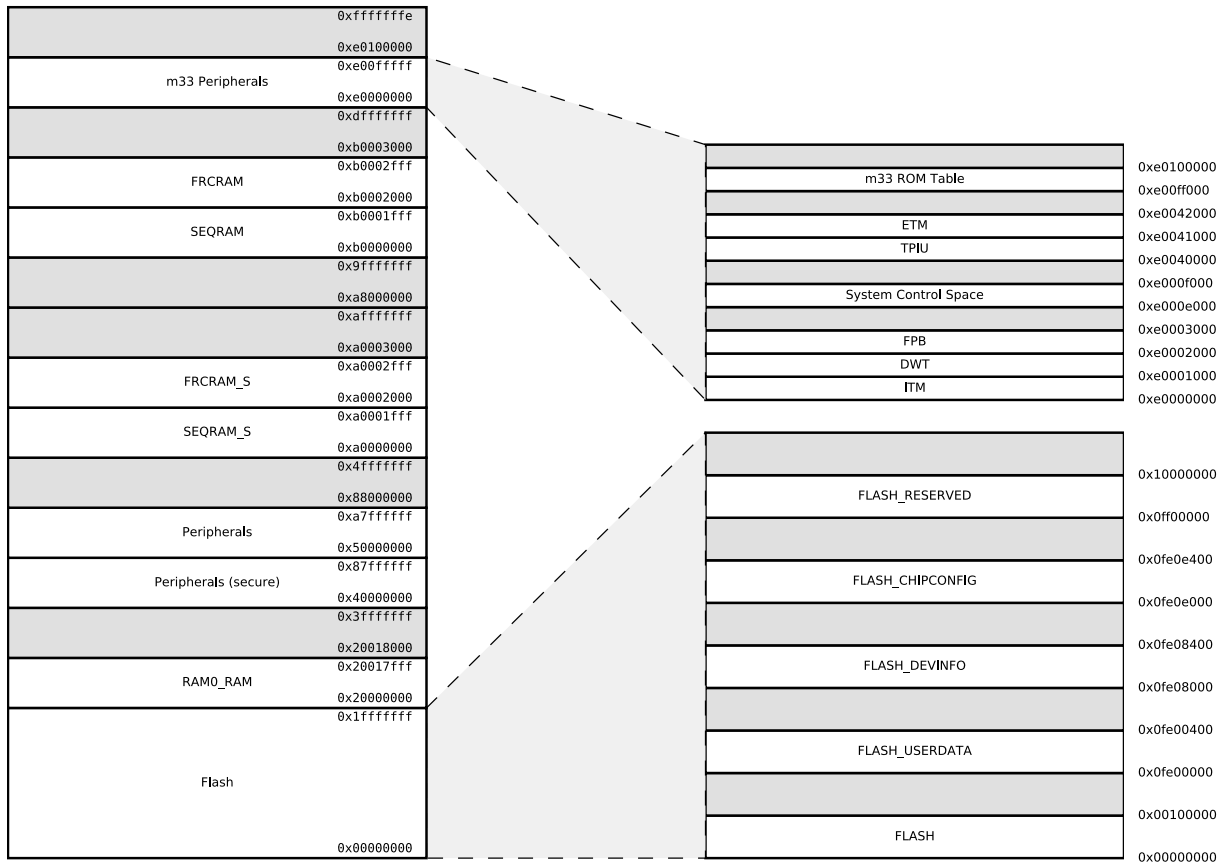

Figure 3.2. EFR32MG21 Memory Map — Core Peripherals and Code Space

### 3.12 Configuration Summary

The features of the EFR32MG21 are a subset of the feature set described in the device reference manual. The table below describes device specific implementation of the features. Remaining modules support full configuration.

**Table 3.1. Configuration Summary**

Module	Lowest Energy Mode	Configuration
TIMER0	EM1	32-bit, 3-channels, +DTI
TIMER1	EM1	16-bit, 3-channels, +DTI
TIMER2	EM1	16-bit, 3-channels, +DTI
USART0	EM1	+IrDA, +I2S, +SmartCard
USART1	EM1	+IrDA, +I2S, +SmartCard
USART2	EM1	+IrDA, +I2S, +SmartCard
I2C0	EM2	
I2C1	EM1	

## 4. Electrical Specifications

### 4.1 Electrical Characteristics

All electrical parameters in all tables are specified under the following conditions, unless stated otherwise:

- Typical values are based on  $T_A=25\text{ }^\circ\text{C}$  and all supplies at 3.0 V, by production test and/or technology characterization.
- Radio performance numbers are measured in conducted mode, based on Silicon Laboratories reference designs using output power-specific external RF impedance-matching networks for interfacing to a 50  $\Omega$  antenna.
- Minimum and maximum values represent the worst conditions across supply voltage, process variation, and operating temperature, unless stated otherwise.

#### 4.1.1 Absolute Maximum Ratings

Stresses above those listed below may cause permanent damage to the device. This is a stress rating only and functional operation of the devices at those or any other conditions above those indicated in the operation listings of this specification is not implied. Exposure to maximum rating conditions for extended periods may affect device reliability. For more information on the available quality and reliability data, see the Quality and Reliability Monitor Report at <http://www.silabs.com/support/quality/pages/default.aspx>.

**Table 4.1. Absolute Maximum Ratings**

Parameter	Symbol	Test Condition	Min	Typ	Max	Unit
Storage temperature range	$T_{STG}$		-50	—	+150	$^\circ\text{C}$
Junction temperature	$T_{JMAX}$	-I grade	—	—	+135	$^\circ\text{C}$
Voltage on any supply pin	$V_{DDMAX}$		-0.3	—	3.8	V
Voltage ramp rate on any supply pin	$V_{DDRAMPMAX}$		—	—	1.0	V / $\mu\text{s}$
Voltage on HFXO pins	$V_{HFXOPIN}$		-0.3	—	1.2	V
DC voltage on any GPIO pin	$V_{DIGPIN}$		-0.3	—	$V_{IOVDD} + 0.3$	V
Input RF level on pins RF2G4_IO1 and RF2G4_IO2	$P_{RFMAX2G4}$		—	—	+10	dBm
Absolute voltage on RF pins RF2G4_IOx	$V_{MAX2G4}$		-0.3	—	$V_{PAVDD}$	V
Total current into VDD power lines	$I_{VDDMAX}$	Source	—	—	200	mA
Total current into VSS ground lines	$I_{VSSMAX}$	Sink	—	—	200	mA
Current per I/O pin	$I_{IOMAX}$	Sink	—	—	50	mA
		Source	—	—	50	mA
Current for all I/O pins	$I_{IOALLMAX}$	Sink	—	—	200	mA
		Source	—	—	200	mA

### 4.1.2 General Operating Conditions

This table specifies the general operating temperature range and supply voltage range for all supplies. The minimum and maximum values of all other tables are specified over this operating range, unless otherwise noted.

**Table 4.2. General Operating Conditions**

Parameter	Symbol	Test Condition	Min	Typ	Max	Unit
Operating ambient temperature range	$T_A$	-I temperature grade <sup>1</sup>	-40	—	+125	° C
DVDD supply voltage	$V_{DVDD}$	EM0/1	1.71	3.0	3.8	V
		EM2/3/4 <sup>2</sup>	1.71	3.0	3.8	V
AVDD supply voltage	$V_{AVDD}$		1.71	3.0	3.8	V
IOVDDx operating supply voltage (All IOVDD pins)	$V_{IOVDDx}$		1.71	3.0	3.8	V
PAVDD operating supply voltage	$V_{PAVDD}$		1.71	3.0	3.8	V
RFVDD operating supply voltage	$V_{RFVDD}$		1.71	3.0	$V_{PAVDD}$	V
DECOUPLE output capacitor <sup>3</sup>	$C_{DECOUPLE}$		0.75	1.0	2.75	μF
HCLK and Core frequency	$f_{HCLK}$	MODE = WS1, RAMWSEN = 1 <sup>4</sup>	—	—	80	MHz
		MODE = WS1, RAMWSEN = 0 <sup>4</sup>	—	—	50	MHz
		MODE = WS0, RAMWSEN = 0 <sup>4</sup>	—	—	39	MHz
PCLK frequency	$f_{PCLK}$		—	—	50	MHz
EM01 Group A clock frequency	$f_{EM01GRPACLK}$		—	—	80	MHz
HCLK Radio frequency <sup>5</sup>	$f_{HCLKRADIO}$		38	38.4	40	MHz

**Note:**

1. The device may operate continuously at the maximum allowable ambient  $T_A$  rating as long as the absolute maximum  $T_{JMAX}$  is not exceeded. For an application with significant power dissipation, the allowable  $T_A$  may be lower than the maximum  $T_A$  rating.  $T_A = T_{JMAX} - (THETA_{JA} \times PowerDissipation)$ . Refer to the Absolute Maximum Ratings table and the Thermal Characteristics table for  $T_{JMAX}$  and  $THETA_{JA}$ .
2. The DVDD supply is monitored by the DVDD BOD in EM0/1 and the LE DVDD BOD in EM2/3/4.
3. The system designer should consult the characteristic specs of the capacitor used on DECOUPLE to ensure its capacitance value stays within the specified bounds across temperature and DC bias.
4. Flash wait states are set by the MODE field in the MSC\_READCTRL register. RAM wait states are enabled by setting the RAMWSEN bit in the SYSYCFG\_DMEM0RAMCTRL register.
5. The recommended radio crystal frequency is 38.4 MHz. Any crystal frequency other than 38.4 is expressly not supported. The minimum and maximum HCLKRADIO frequency in this table represent the design limits, which are much wider than the typical crystal tolerance.

### 4.1.3 Thermal Characteristics

**Table 4.3. Thermal Characteristics**

Parameter	Symbol	Test Condition	Min	Typ	Max	Unit
Thermal Resistance Junction to Ambient QFN32 (4x4mm) Package	THE-TA <sub>JA_QFN32_4X4</sub>	2-Layer PCB, Natural Convection <sup>1</sup>	—	94.3	—	°C/W
		4-Layer PCB, Natural Convection <sup>1</sup>	—	35.4	—	°C/W
Thermal Resistance Junction to Case QFN32 (4x4mm) Package	THE-TA <sub>JC_QFN32_4X4</sub>	2-Layer PCB, Natural Convection <sup>1</sup>	—	36.3	—	°C/W
		4-Layer PCB, Natural Convection <sup>1</sup>	—	23.5	—	°C/W

**Note:**

1. Measured according to JEDEC standard JESD51-2A. Integrated Circuit Thermal Test Method Environmental Conditions - Natural Convection (Still Air).



#### 4.1.4 Current Consumption

##### 4.1.4.1 MCU current consumption at 1.8V

Unless otherwise indicated, typical conditions are: AVDD = DVDD = RFVDD = PAVDD = 1.8V. T<sub>A</sub> = 25 °C. Minimum and maximum values in this table represent the worst conditions across process variation at T<sub>A</sub> = 25 °C.

**Table 4.4. MCU current consumption at 1.8V**

Parameter	Symbol	Test Condition	Min	Typ	Max	Unit
Current consumption in EM0 mode with all peripherals disabled <sup>1</sup>	I <sub>ACTIVE</sub>	80 MHz HFRCO, CPU running Prime from flash	—	50.9	—	µA/MHz
		80 MHz HFRCO, CPU running while loop from flash	—	45.5	—	µA/MHz
		80 MHz HFRCO, CPU running CoreMark loop from flash	—	59.7	—	µA/MHz
		38.4 MHz crystal, CPU running while loop from flash	—	63.6	—	µA/MHz
		38 MHz HFRCO, CPU running while loop from flash	—	55.5	—	µA/MHz
		26 MHz HFRCO, CPU running while loop from flash	—	59.1	—	µA/MHz
		16 MHz HFRCO, CPU running while loop from flash	—	67.0	—	µA/MHz
		1 MHz HFRCO, CPU running while loop from flash	—	360	—	µA/MHz
Current consumption in EM1 mode with all peripherals disabled <sup>1</sup>	I <sub>EM1</sub>	80 MHz HFRCO	—	28.7	—	µA/MHz
		38.4 MHz crystal	—	46.7	—	µA/MHz
		38 MHz HFRCO	—	38.7	—	µA/MHz
		26 MHz HFRCO	—	42.2	—	µA/MHz
		16 MHz HFRCO	—	50.0	—	µA/MHz
		1 MHz HFRCO	—	343	—	µA/MHz
Current consumption in EM2 mode	I <sub>EM2</sub>	Full RAM retention and RTC running from LFXO	—	5.0	—	µA
		Full RAM retention and RTC running from LFRCO	—	5.0	—	µA
		1 bank (16kB) RAM retention and RTC running from LFRCO	—	4.5	—	µA
Current consumption in EM3 mode	I <sub>EM3</sub>	Full RAM retention and RTC running from ULFRCO	—	4.7	—	µA
		1 bank (16kB) RAM retention and RTC running from ULFRCO	—	4.2	—	µA
Current consumption in EM4 mode	I <sub>EM4</sub>	No BURTC, no LF oscillator	—	0.14	—	µA
		BURTC with LFXO	—	0.51	—	µA
Current consumption during reset	I <sub>RST</sub>	Hard pin reset held	—	107	—	µA

Parameter	Symbol	Test Condition	Min	Typ	Max	Unit
Current Consumption per retained 16kB RAM bank in EM2	$I_{RAM}$		—	0.10	—	$\mu A$

**Note:**

1. The typical EM0/EM1 current measurement includes some current consumed by the security core for periodical housekeeping purposes. This does not include current consumed by user-triggered security operations, such as cryptographic calculations.

#### 4.1.4.2 MCU current consumption at 3.0V

Unless otherwise indicated, typical conditions are: AVDD = DVDD = RFVDD = PAVDD = 3.0 V. T<sub>A</sub> = 25 °C. Minimum and maximum values in this table represent the worst conditions across process variation at T<sub>A</sub> = 25 °C.

**Table 4.5. MCU current consumption at 3.0V**

Parameter	Symbol	Test Condition	Min	Typ	Max	Unit
Current consumption in EM0 mode with all peripherals disabled <sup>1</sup>	I <sub>ACTIVE</sub>	80 MHz HFRCO, CPU running Prime from flash	—	50.9	—	µA/MHz
		80 MHz HFRCO, CPU running while loop from flash	—	45.6	55.5	µA/MHz
		80 MHz HFRCO, CPU running CoreMark loop from flash	—	59.8	—	µA/MHz
		38.4 MHz crystal, CPU running while loop from flash	—	63.8	—	µA/MHz
		38 MHz HFRCO, CPU running while loop from flash	—	55.6	75.1	µA/MHz
		26 MHz HFRCO, CPU running while loop from flash	—	59.1	—	µA/MHz
		16 MHz HFRCO, CPU running while loop from flash	—	67.1	—	µA/MHz
		1 MHz HFRCO, CPU running while loop from flash	—	362	1018	µA/MHz
Current consumption in EM1 mode with all peripherals disabled <sup>1</sup>	I <sub>EM1</sub>	80 MHz HFRCO	—	28.7	37.6	µA/MHz
		38.4 MHz crystal	—	46.9	—	µA/MHz
		38 MHz HFRCO	—	38.7	57.5	µA/MHz
		26 MHz HFRCO	—	42.2	—	µA/MHz
		16 MHz HFRCO	—	50.2	—	µA/MHz
		1 MHz HFRCO	—	345	994	µA/MHz
Current consumption in EM2 mode	I <sub>EM2</sub>	Full RAM retention and RTC running from LFXO	—	5.1	—	µA
		Full RAM retention and RTC running from LFRCO	—	5.0	—	µA
		1 bank (16 kB) RAM retention and RTC running from LFRCO	—	4.5	10.5	µA
Current consumption in EM3 mode	I <sub>EM3</sub>	Full RAM retention and RTC running from ULFRCO	—	4.8	11.4	µA
		1 bank (16 kB) RAM retention and RTC running from ULFRCO	—	4.3	—	µA
Current consumption in EM4 mode	I <sub>EM4</sub>	No BURTC, no LF oscillator	—	0.21	0.5	µA
		BURTC with LFXO	—	0.61	—	µA
Current consumption during reset	I <sub>RST</sub>	Hard pin reset held	—	146	—	µA
Current consumption per retained 16kB RAM bank in EM2	I <sub>RAM</sub>		—	0.10	—	µA

Parameter	Symbol	Test Condition	Min	Typ	Max	Unit
<b>Note:</b>						
1. The typical EM0/EM1 current measurement includes some current consumed by the security core for periodical housekeeping purposes. This does not include current consumed by user-triggered security operations, such as cryptographic calculations.						

#### 4.1.4.3 Radio current consumption at 1.8V

RF current consumption measured with MCU in EM1, HCLK = 38.4 MHz, and all MCU peripherals disabled. Unless otherwise indicated, typical conditions are: AVDD = DVDD = IOVDD = RFVDD = PAVDD = 1.8V. Minimum and maximum values in this table represent the worst conditions across process variation at  $T_A = 25\text{ }^\circ\text{C}$ .

**Table 4.6. Radio current consumption at 1.8V**

Parameter	Symbol	Test Condition	Min	Typ	Max	Unit
Current consumption in receive mode, active packet reception	$I_{RX\_ACTIVE}$	125 kbit/s, 2GFSK, f = 2.4 GHz	—	9.0	—	mA
		500 kbit/s, 2GFSK, f = 2.4 GHz	—	9.1	—	mA
		1 Mbit/s, 2GFSK, f = 2.4 GHz	—	8.8	—	mA
		2 Mbit/s, 2GFSK, f = 2.4 GHz	—	9.4	—	mA
		802.15.4 receiving frame, f = 2.4 GHz	—	9.4	—	mA
Current consumption in receive mode, listening for packet	$I_{RX\_LISTEN}$	125 kbit/s, 2GFSK, f = 2.4 GHz	—	9.0	—	mA
		500 kbit/s, 2GFSK, f = 2.4 GHz	—	9.0	—	mA
		1 Mbit/s, 2GFSK, f = 2.4 GHz	—	9.0	—	mA
		2 Mbit/s, 2GFSK, f = 2.4 GHz	—	9.8	—	mA
		802.15.4, f = 2.4 GHz	—	9.2	—	mA
Current consumption in transmit mode	$I_{TX}$	f = 2.4 GHz, CW, 0 dBm PA, 0 dBm output power	—	9.3	—	mA
		f = 2.4 GHz, CW, 10 dBm PA, 0 dBm output power	—	16.6	—	mA
		f = 2.4 GHz, CW, 10 dBm PA, 10 dBm output power	—	33.8	—	mA

#### 4.1.4.4 Radio current consumption at 3.0V

RF current consumption measured with MCU in EM1, HCLK = 38.4 MHz, and all MCU peripherals disabled. Unless otherwise indicated, typical conditions are: AVDD = DVDD = IOVDD = RFVDD = PAVDD = 3.0V. Minimum and maximum values in this table represent the worst conditions across process variation at  $T_A = 25^\circ\text{C}$ .

**Table 4.7. Radio current consumption at 3.0V**

Parameter	Symbol	Test Condition	Min	Typ	Max	Unit
Current consumption in receive mode, active packet reception	I <sub>RX_ACTIVE</sub>	125 kbit/s, 2GFSK, f = 2.4 GHz	—	9.0	—	mA
		500 kbit/s, 2GFSK, f = 2.4 GHz	—	9.1	—	mA
		1 Mbit/s, 2GFSK, f = 2.4 GHz	—	8.8	—	mA
		2 Mbit/s, 2GFSK, f = 2.4 GHz	—	9.4	—	mA
		802.15.4 receiving frame, f = 2.4 GHz	—	9.5	—	mA
Current consumption in receive mode, listening for packet	I <sub>RX_LISTEN</sub>	125 kbit/s, 2GFSK, f = 2.4 GHz	—	9.0	—	mA
		500 kbit/s, 2GFSK, f = 2.4 GHz	—	9.0	—	mA
		1 Mbit/s, 2GFSK, f = 2.4 GHz	—	9.0	—	mA
		2 Mbit/s, 2GFSK, f = 2.4 GHz	—	9.8	—	mA
		802.15.4, f = 2.4 GHz	—	9.2	—	mA
Current consumption in transmit mode	I <sub>TX</sub>	f = 2.4 GHz, CW, 0 dBm PA, 0 dBm output power	—	10.5	—	mA
		f = 2.4 GHz, CW, 10 dBm PA, 0 dBm output power	—	16.7	—	mA
		f = 2.4 GHz, CW, 10 dBm PA, 10 dBm output power	—	34.0	—	mA
		f = 2.4 GHz, CW, 20 dBm PA, 10 dBm output power, PAVDD = 3.0 V	—	60.8	—	mA
		f = 2.4 GHz, CW, 20 dBm PA, 20 dBm output power, PAVDD = 3.3 V	—	185	—	mA

## 4.1.5 2.4 GHz RF Transceiver Characteristics

### 4.1.5.1 RF Transmitter Characteristics

#### 4.1.5.1.1 RF Transmitter General Characteristics for the 2.4 GHz Band

Unless otherwise indicated, typical conditions are:  $T_A = 25\text{ }^\circ\text{C}$ ,  $PAVDD = 3.0\text{V}$ ,  $AVDD = DVDD = IOVDD = RFVDD = PAVDD$ . Crystal frequency=38.4 MHz. RF center frequency 2.45 GHz. Antenna port 2.

**Table 4.8. RF Transmitter General Characteristics for the 2.4 GHz Band**

Parameter	Symbol	Test Condition	Min	Typ	Max	Unit
RF tuning frequency range	$F_{\text{RANGE}}$		2400	—	2483.5	MHz
Maximum TX power <sup>1</sup>	$POUT_{\text{MAX}}$	20 dBm PA, $PAVDD = 3.3\text{V}$	—	+20.2	—	dBm
Maximum TX power	$POUT_{\text{MAX}10}$	10 dBm PA	—	+10.5	—	dBm
Maximum TX power	$POUT_{\text{MAX}0}$	0 dBm PA	—	+0.4	—	dBm
Minimum active TX Power	$POUT_{\text{MIN}}$	20 dBm PA, $PAVDD = 3.3\text{ V}$	—	-20.5	—	dBm
		10 dBm PA	—	-19.3	—	dBm
		0 dBm PA	—	-23.5	—	dBm
Output power step size	$POUT_{\text{STEP}}$	0 dBm PA, -15 dBm < Output Power < -5 dBm	—	1.5	—	dB
		0 dBm PA, -5 dBm < Output Power < 0 dBm	—	0.3	—	dB
		10 dBm PA, -5 dBm < Output power < 0 dBm	—	1.5	—	dB
		10 dBm PA, 0 dBm < output power < 10 dBm	—	1.0	—	dB
		20 dBm PA, 0 dBm < Output Power < 5 dBm	—	0.7	—	dB
		20 dBm PA, 5 dBm < output power < $POUT_{\text{MAX}}$	—	0.5	—	dB
Output power variation vs $PAVDD$ supply voltage variation, frequency = 2450MHz	$POUT_{\text{VAR}_V}$	20 dBm PA $P_{\text{out}} = POUT_{\text{MAX}}$ output power with $PAVDD$ voltage swept from 3.0V to 3.8V.	—	0.8	—	dB
		10 dbm PA output power with $PAVDD$ voltage swept from 1.8 V to 3.0 V	—	0.1	—	dB
		0 dBm PA output power with $PAVDD$ voltage swept from 1.8 V to 3.0 V	—	0.1	—	dB
Output power variation vs temperature, Frequency = 2450MHz	$POUT_{\text{VAR}_T}$	$AVDD = 3.3\text{V}$ supply, 20 dBm PA at $P_{\text{out}} = POUT_{\text{MAX}}$ , (-40 to +125 $^\circ\text{C}$ )	—	1.5	—	dB
		10 dBm PA at 10 dBm, (-40 to +125 $^\circ\text{C}$ )	—	0.3	—	dB
		0 dBm PA at 0 dBm, (-40 to +125 $^\circ\text{C}$ )	—	2.1	—	dB

Parameter	Symbol	Test Condition	Min	Typ	Max	Unit
Output power variation vs RF frequency	$POUT_{VAR\_F}$	20 dBm PA, $POUT_{MAX}$ , PAVDD = 3.3 V.	—	0.2	—	dB
		10 dBm PA, 10 dBm	—	0.2	—	dB
		0 dBm PA, 0 dBm	—	0.1	—	dB
Spurious emissions of harmonics in restricted bands per FCC Part 15.205/15.209	$SPUR_{HRM\_FCC\_R}$	Continuous transmission of CW carrier. $P_{out} = POUT_{MAX}$ , PAVDD = 3.3V. Test Frequency = 2450MHz.	—	-47	—	dBm
		Continuous transmission of CW carrier, $P_{out} = 10$ dBm, Test Frequency = 2450 MHz.	—	-47	—	dBm
Spurious emissions of harmonics in non-restricted bands per FCC Part 15.247/15.35	$SPUR_{HRM\_FCC\_NRR}$	Continuous transmission of CW carrier, $P_{out} = POUT_{MAX}$ , PAVDD = 3.3V, Test Frequency = 2450MHz.	—	-26	—	dBc
		Continuous transmission of CW carrier. $P_{out} = 10$ dBm. Test Frequency = 2450 MHz.	—	-26	—	dBc

Parameter	Symbol	Test Condition	Min	Typ	Max	Unit
Spurious emissions out-of-band (above 2.483 GHz or below 2.4 GHz) in restricted bands, per FCC part 15.205/15.209	SPUR <sub>OOB_FCC_R</sub>	Restricted bands 30-88 MHz, Continuous transmission of CW carrier, 20 dBm PA, P <sub>out</sub> = POUT <sub>MAX</sub> , PAVDD = 3.3V. Test Frequency = 2450MHz.	—	-47	—	dBm
		Restricted bands 88 - 216 MHz, Continuous transmission of CW carrier, 20 dBm PA, P <sub>out</sub> = POUT <sub>MAX</sub> , PAVDD = 3.3V. Test Frequency = 2450MHz.	—	-47	—	dBm
		Restricted bands 216 - 960 MHz, Continuous transmission of CW carrier, 20 dBm PA P <sub>out</sub> = POUT <sub>MAX</sub> , PAVDD = 3.3V. Test Frequency = 2450MHz.	—	-47	—	dBm
		Restricted bands >960 MHz, Continuous transmission of CW carrier, 20 dBm PA, P <sub>out</sub> = POUT <sub>MAX</sub> , PAVDD = 3.3V, Test Frequency = 2450MHz.	—	-47	—	dBm
		Restricted bands 30-88 MHz, Continuous transmission of CW carrier, P <sub>out</sub> = 10 dBm, Test Frequency = 2450 MHz	—	-47	—	dBm
		Restricted bands 88 - 216 MHz, Continuous transmission of CW carrier, P <sub>out</sub> = 10 dBm, Test Frequency = 2450 MHz	—	-47	—	dBm
		Restricted bands 216 - 960 MHz, Continuous transmission of CW carrier, P <sub>out</sub> = 10 dBm, Test Frequency = 2450 MHz	—	-47	—	dBm
		Restricted bands > 960 MHz, Continuous transmission of CW carrier, P <sub>out</sub> = 10 dBm, Test Frequency = 2450 MHz	—	-47	—	dBm
		Spurious emissions per ETSI EN300.440	SPUR <sub>ETSI440</sub>	1G-14G, P <sub>out</sub> = 10 dBm, Test Frequency = 2450 MHz	—	-36
47-74 MHz, 87.5-108 MHz, 174-230 MHz, 470-862 MHz, P <sub>out</sub> = 10 dBm, Test Frequency = 2450 MHz	—			-56	—	dBm
25-1000 MHz, excluding above frequencies. P <sub>out</sub> = 10 dBm, Test Frequency = 2450 MHz	—			-42	—	dBm
1G-12.75 GHz, excluding bands listed above, P <sub>out</sub> = 10 dBm, Test Frequency = 2450MHz.	—			-50	—	dBm



Parameter	Symbol	Test Condition	Min	Typ	Max	Unit
Spurious emissions out-of-band in non-restricted bands per FCC Part 15.247	SPUR <sub>OOB_FCC_NR</sub>	Frequencies above 2.483 GHz or below 2.4 GHz, continuous transmission CW carrier, 20 dBm PA, P <sub>out</sub> = P <sub>OUT_MAX</sub> , PAVDD = 3.3 V, Test Frequency = 2450 MHz	—	-26	—	dBc
		Frequencies above 2.483 GHz or below 2.4 GHz, continuous transmission CW carrier, P <sub>out</sub> = 10 dBm, Test Frequency = 2450 MHz	—	-26	—	dBc
Spurious emissions out-of-band, per ETSI 300.328	SPUR <sub>ETSI328</sub>	[2400-2BW to 2400-BW], [2483.5+BW to 2483.5+2BW], P <sub>out</sub> = 10 dBm, Test Frequency = 2450 MHz	—	-26	—	dBm
		[2400-BW to 2400], [2483.5 to 2483.5+BW] P <sub>out</sub> = 10 dBm, Test Frequency = 2450MHz.	—	-16	—	dB

**Note:**

1. Supported transmit power levels are determined by the ordering part number (OPN). Transmit power ratings for all devices covered in this data sheet can be found in the Max TX Power column of the Ordering Information Table.

#### 4.1.5.1.2 RF Transmitter Characteristics for 802.15.4 DSSS-OQPSK in the 2.4 GHz Band

Unless otherwise indicated, typical conditions are:  $T_A = 25\text{ }^\circ\text{C}$ ,  $PAVDD = 3.0\text{V}$ ,  $AVDD = DVDD = IOVDD = RFVDD = PAVDD$ . Crystal frequency=38.4 MHz. RF center frequency 2.45 GHz. Antenna port 2.

**Table 4.9. RF Transmitter Characteristics for 802.15.4 DSSS-OQPSK in the 2.4 GHz Band**

Parameter	Symbol	Test Condition	Min	Typ	Max	Unit
Error vector magnitude per 802.15.4-2011	EVM	Average across frequency, signal is DSSS-OQPSK reference packet, $PAVDD = 3.3\text{ V}$ , $P_{out} = P_{OUT_{MAX}}$	—	2.7	—	% rms
		Average across frequency, signal is DSSS-OQPSK reference packet, $P_{out} = 10\text{ dBm}$	—	2.7	—	% rms
		Average across frequency, signal is DSSS-OQPSK reference packet, $P_{out} = 0\text{ dBm}$	—	2.8	—	% rms
Power spectral density limit	PSD <sub>LIMIT</sub>	Relative, at carrier $\pm 3.5\text{ MHz}$ , $PAVDD = 3.3\text{ V}$ , $P_{out} = P_{OUT_{MAX}}$	—	-50.3	—	dBc/100kHz
		Relative, at carrier $\pm 3.5\text{ MHz}$ , $P_{out} = 10\text{ dBm}$	—	-50.7	—	dBc/100kHz
		Relative, at carrier $\pm 3.5\text{ MHz}$ , $P_{out} = 0\text{ dBm}$	—	-50.7	—	dBc/100kHz
		Absolute, at carrier $\pm 3.5\text{ MHz}$ , $PAVDD = 3.3\text{ V}$ , $P_{out} = P_{OUT_{MAX}}$	—	-38.8	—	dBm/100kHz
		Absolute, at carrier $\pm 3.5\text{ MHz}$ , $P_{out} = 10\text{ dBm}$	—	-49	—	dBm/100kHz
		Absolute, at carrier $\pm 3.5\text{ MHz}$ , $P_{out} = 0\text{ dBm}$	—	-58.9	—	dBm/100kHz
		Per FCC part 15.247, $PAVDD = 3.3\text{ V}$ , $P_{out} = P_{OUT_{MAX}}$	—	+5.6	—	dBm/3kHz
		Per FCC part 15.247, $P_{out} = 10\text{ dBm}$	—	-4.4	—	dBm/3kHz
		Per FCC part 15.247, $P_{out} = 0\text{ dBm}$	—	-14.2	—	dBm/3kHz
		ETSI 300.328 $P_{out} = 10\text{ dBm}$	—	+8.1	—	dBm
		ETSI 300.328 $P_{out} = 0\text{ dBm}$	—	-1.9	—	dBm
Occupied channel bandwidth per ETSI EN300.328	OCP <sub>ETSI328</sub>	99% BW at highest and lowest channels in band, $P_{out} = 10\text{ dBm}$	—	2.3	—	MHz
		99% BW at highest and lowest channels in band, $P_{out} = 0\text{ dBm}$	—	2.2	—	MHz

#### 4.1.5.1.3 RF Transmitter Characteristics for Bluetooth Low Energy in the 2.4 GHz Band 1 Mbps Data Rate

Unless otherwise indicated, typical conditions are:  $T_A = 25\text{ }^\circ\text{C}$ ,  $P_{AVDD} = 3.0\text{V}$ ,  $AVDD = DVDD = IOVDD = RFVDD = PAVDD$ . Crystal frequency=38.4 MHz. RF center frequency 2.45 GHz. Antenna port 2.

**Table 4.10. RF Transmitter Characteristics for Bluetooth Low Energy in the 2.4 GHz Band 1 Mbps Data Rate**

Parameter	Symbol	Test Condition	Min	Typ	Max	Unit
Transmit 6 dB bandwidth	TXBW	$P_{AVDD} = 3.3\text{ V}$ , $P_{out} = P_{OUT_{MAX}}$	—	635.1	—	kHz
		$P_{out} = 10\text{ dBm}$	—	672.9	—	kHz
		$P_{out} = 0\text{ dBm}$	—	646.5	—	kHz
Power spectral density limit	PSD <sub>LIMIT</sub>	$P_{AVDD} = 3.3\text{ V}$ , $P_{out} = P_{OUT_{MAX}}$ , Per FCC part 15.247	—	+6.4	—	dBm/ 3kHz
		$P_{out} = 10\text{ dBm}$ , Per FCC part 15.247 at 10 dBm	—	-3.7	—	dBm/ 3kHz
		$P_{out} = 0\text{ dBm}$ , Per FCC part 15.247 at 0 dBm	—	-13.6	—	dBm/ 3kHz
		Per ETSI 300.328 at 10 dBm/1 MHz	—	+10.2	—	dBm
Occupied channel bandwidth per ETSI EN300.328	OCP <sub>ETSI328</sub>	$P_{out} = 10\text{ dBm}$ 99% BW at highest and lowest channels in band	—	1.1	—	MHz
		$P_{out} = 0\text{ dBm}$ 99% BW at highest and lowest channels in band	—	1.1	—	MHz
In-band spurious emissions, with allowed exceptions <sup>1</sup>	SPUR <sub>INB</sub>	$P_{AVDD} = 3.3\text{ V}$ , $P_{out} = P_{OUT_{MAX}}$ , Inband spurs at $\pm 2\text{ MHz}$	—	-26.3	—	dBm
		$P_{out} = 10\text{ dbm}$ , Inband spurs at $\pm$ 2 MHz	—	-36.4	—	dBm
		$P_{out} = 0\text{ dbm}$ , Inband spurs at $\pm 2$ MHz	—	-46.3	—	dBm
		$P_{AVDD} = 3.3\text{ V}$ , $P_{out} = P_{OUT_{MAX}}$ Inband spurs at $\pm 3\text{ MHz}$	—	-20	—	dBm
		$P_{out} = 10\text{ dBm}$ Inband spurs at $\pm 3$ MHz	—	-41.9	—	dBm
		$P_{out} = 0\text{dbm}$ Inband spurs at $\pm 3$ MHz	—	-51.5	—	dBm

**Note:**

1. Per Bluetooth Core\_5.1, Vol.6 Part A, Section 3.2.2, exceptions are allowed in up to three bands of 1 MHz width, centered on a frequency which is an integer multiple of 1 MHz. These exceptions shall have an absolute value of -20 dBm or less.

#### 4.1.5.1.4 RF Transmitter Characteristics for Bluetooth Low Energy in the 2.4 GHz Band 2 Mbps Data Rate

Unless otherwise indicated, typical conditions are:  $T_A = 25\text{ }^\circ\text{C}$ ,  $P_{AVDD} = 3.0\text{V}$ ,  $AVDD = DVDD = IOVDD = RFVDD = PAVDD$ . Crystal frequency=38.4 MHz. RF center frequency 2.45 GHz. Antenna port 2.

**Table 4.11. RF Transmitter Characteristics for Bluetooth Low Energy in the 2.4 GHz Band 2 Mbps Data Rate**

Parameter	Symbol	Test Condition	Min	Typ	Max	Unit
Transmit 6 dB bandwidth	TXBW	$P_{AVDD} = 3.3\text{ V}$ , $P_{out} = P_{OUT_{MAX}}$	—	1238.6	—	kHz
		$P_{out} = 10\text{ dBm}$	—	1182.5	—	kHz
		$P_{out} = 0\text{ dBm}$	—	1249.7	—	kHz
Power spectral density limit	PSD <sub>LIMIT</sub>	$P_{AVDD} = 3.3\text{ V}$ , $P_{out} = P_{OUT_{MAX}}$ , Per FCC part 15.247	—	+3.7	—	dBm/ 3kHz
		$P_{out} = 10\text{ dBm}$ , Per FCC part 15.247 at 10 dBm	—	-6.4	—	dBm/ 3kHz
		$P_{out} = 0\text{ dBm}$ , Per FCC part 15.247 at 0 dBm	—	-16.2	—	dBm/ 3kHz
		Per ETSI 300.328 at 10 dBm/1 MHz	—	+9.0	—	dBm
Occupied channel bandwidth per ETSI EN300.328	OCP <sub>ETSI328</sub>	$P_{out} = 10\text{ dBm}$ 99% BW at highest and lowest channels in band	—	2.1	—	MHz
		$P_{out} = 0\text{ dBm}$ 99% BW at highest and lowest channels in band	—	2.1	—	MHz
In-band spurious emissions, with allowed exceptions <sup>1</sup>	SPUR <sub>INB</sub>	$P_{AVDD} = 3.3\text{ V}$ $P_{out} = P_{OUT_{MAX}}$ , Inband spurs at $\pm 2\text{ MHz}$	—	-31.7	—	dBm
		$P_{out} = 10\text{ dBm}$ , Inband spurs at $\pm$ 4 MHz	—	-41.9	—	dBm
		$P_{out} = 0\text{ dBm}$ , Inband spurs at $\pm 4$ MHz	—	-51.7	—	dBm
		$P_{AVDD} = 3.3\text{ V}$ $P_{out} = P_{OUT_{MAX}}$ Inband spurs at $\pm 6\text{ MHz}$	—	-35.7	—	dBm
		$P_{out} = 10\text{ dBm}$ Inband spurs at $\pm 6$ MHz	—	-46.0	—	dBm
		$P_{out} = 0\text{ dbm}$ Inband spurs at $\pm 6$ MHz	—	-55.7	—	dBm

**Note:**

1. Per Bluetooth Core\_5.1, Vol.6 Part A, Section 3.2.2, exceptions are allowed in up to three bands of 1 MHz width, centered on a frequency which is an integer multiple of 1 MHz. These exceptions shall have an absolute value of -20 dBm or less.

#### 4.1.5.1.5 RF Transmitter Characteristics for Bluetooth Low Energy in the 2.4 GHz Band 500 kbps Data Rate

Unless otherwise indicated, typical conditions are:  $T_A = 25\text{ }^\circ\text{C}$ ,  $P_{AVDD} = 3.0\text{V}$ ,  $AVDD = DVDD = IOVDD = RFVDD = PAVDD$ . Crystal frequency=38.4 MHz. RF center frequency 2.45 GHz. Antenna port 2.

**Table 4.12. RF Transmitter Characteristics for Bluetooth Low Energy in the 2.4 GHz Band 500 kbps Data Rate**

Parameter	Symbol	Test Condition	Min	Typ	Max	Unit
Transmit 6 dB bandwidth	TXBW	$P_{AVDD} = 3.3\text{ V}$ , $P_{out} = P_{OUT_{MAX}}$	—	770.9	—	kHz
		$P_{out} = 10\text{ dBm}$	—	760.1	—	kHz
		$P_{out} = 0\text{ dBm}$	—	775.1	—	kHz
Power spectral density limit	PSD <sub>LIMIT</sub>	$P_{AVDD} = 3.3\text{ V}$ , $P_{out} = P_{OUT_{MAX}}$ , Per FCC part 15.247	—	+5.4	—	dBm/ 3kHz
		$P_{out} = 10\text{ dBm}$ , Per FCC part 15.247 at 10 dBm	—	-4.6	—	dBm/ 3kHz
		$P_{out} = 0\text{ dBm}$ , Per FCC part 15.247 at 0 dBm	—	-14.4	—	dBm/ 3kHz
		Per ETSI 300.328 at 10 dBm/1 MHz	—	+10.2	—	dBm
Occupied channel bandwidth per ETSI EN300.328	OCP <sub>ETSI328</sub>	$P_{out} = 10\text{ dBm}$ 99% BW at highest and lowest channels in band	—	1.1	—	MHz
		$P_{out} = 0\text{ dBm}$ 99% BW at highest and lowest channels in band	—	1.1	—	MHz
In-band spurious emissions, with allowed exceptions <sup>1</sup>	SPUR <sub>INB</sub>	$P_{out} = 10\text{ dbm}$ , Inband spurs at $\pm$ 2 MHz	—	-38.3	—	dBm
		$P_{out} = 0\text{ dbm}$ , Inband spurs at $\pm$ 2 MHz	—	-47.6	—	dBm
		$P_{AVDD} = 3.3\text{ V}$ , $P_{out} = P_{OUT_{MAX}}$ Inband spurs at $\pm$ 3 MHz	—	-20	—	dBm
		$P_{out} = 10\text{ dBm}$ Inband spurs at $\pm$ 3 MHz	—	-42.3	—	dBm
		$P_{out} = 0\text{ dbm}$ Inband spurs at $\pm$ 3 MHz	—	-51.8	—	dBm

**Note:**

1. Per Bluetooth Core\_5.1, Vol.6 Part A, Section 3.2.2, exceptions are allowed in up to three bands of 1 MHz width, centered on a frequency which is an integer multiple of 1 MHz. These exceptions shall have an absolute value of -20 dBm or less.

#### 4.1.5.1.6 RF Transmitter Characteristics for Bluetooth Low Energy in the 2.4 GHz Band 125 kbps Data Rate

Unless otherwise indicated, typical conditions are:  $T_A = 25\text{ }^\circ\text{C}$ ,  $P_{AVDD} = 3.0\text{V}$ ,  $AVDD = DVDD = IOVDD = RFVDD = PAVDD$ . Crystal frequency=38.4 MHz. RF center frequency 2.45 GHz. Antenna port 2.

**Table 4.13. RF Transmitter Characteristics for Bluetooth Low Energy in the 2.4 GHz Band 125 kbps Data Rate**

Parameter	Symbol	Test Condition	Min	Typ	Max	Unit
Transmit 6 dB bandwidth	TXBW	$P_{AVDD} = 3.3\text{ V}$ , $P_{out} = P_{OUT_{MAX}}$	—	609.7	—	kHz
		$P_{out} = 10\text{ dBm}$	—	619.3	—	kHz
		$P_{out} = 0\text{ dBm}$	—	617.4	—	kHz
Power spectral density limit	PSD <sub>LIMIT</sub>	$P_{AVDD} = 3.3\text{ V}$ , $P_{out} = P_{OUT_{MAX}}$ , Per FCC part 15.247	—	+14.6	—	dBm/ 3kHz
		$P_{out} = 10\text{ dBm}$ , Per FCC part 15.247 at 10 dBm	—	+4.5	—	dBm/ 3kHz
		$P_{out} = 0\text{ dBm}$ , Per FCC part 15.247 at 0 dBm	—	-5.3	—	dBm/ 3kHz
		Per ETSI 300.328 at 10 dBm/1 MHz	—	+10.1	—	dBm
Occupied channel bandwidth per ETSI EN300.328	OCP <sub>ETSI328</sub>	$P_{out} = 10\text{ dBm}$ 99% BW at highest and lowest channels in band	—	1.1	—	MHz
		$P_{out} = 0\text{ dBm}$ 99% BW at highest and lowest channels in band	—	1.1	—	MHz
In-band spurious emissions, with allowed exceptions <sup>1</sup>	SPUR <sub>INB</sub>	$P_{AVDD} = 3.3\text{ V}$ , $P_{out} = P_{OUT_{MAX}}$ , Inband spurs at $\pm 2\text{ MHz}$	—	-27.7	—	dBm
		$P_{out} = 10\text{ dbm}$ , Inband spurs at $\pm$ 2 MHz	—	-38.5	—	dBm
		$P_{out} = 0\text{ dbm}$ , Inband spurs at $\pm 2$ MHz	—	-47.8	—	dBm
		$P_{AVDD} = 3.3\text{ V}$ , $P_{out} = P_{OUT_{MAX}}$ Inband spurs at $\pm 3\text{ MHz}$	—	-20	—	dBm
		$P_{out} = 10\text{ dBm}$ Inband spurs at $\pm 3$ MHz	—	-42.4	—	dBm
		$P_{out} = 0\text{dbm}$ Inband spurs at $\pm 3$ MHz	—	-51.8	—	dBm

**Note:**

1. Per Bluetooth Core\_5.1, Vol.6 Part A, Section 3.2.2, exceptions are allowed in up to three bands of 1 MHz width, centered on a frequency which is an integer multiple of 1 MHz. These exceptions shall have an absolute value of -20 dBm or less.

#### 4.1.5.2 RF Receiver Characteristics

##### 4.1.5.2.1 RF Receiver General Characteristics for the 2.4 GHz Band

Unless otherwise indicated, typical conditions are:  $T_A = 25\text{ }^\circ\text{C}$ ,  $PAVDD = 3.0\text{V}$ ,  $AVDD = DVDD = IOVDD = RFVDD = PAVDD$ . Crystal frequency=38.4 MHz. RF center frequency 2.45 GHz. Antenna port 2.

**Table 4.14. RF Receiver General Characteristics for the 2.4 GHz Band**

Parameter	Symbol	Test Condition	Min	Typ	Max	Unit
RF tuning frequency range	$F_{\text{RANGE}}$		2400	—	2483.5	MHz
Receive mode maximum spurious emission	$SPUR_{\text{RX}}$	30 MHz to 1 GHz	—	-54.8	—	dBm
		1 GHz to 12 GHz	—	-57.1	—	dBm
Max spurious emissions during active receive mode, per FCC Part 15.109(a)	$SPUR_{\text{RX\_FCC}}$	216 MHz to 960 MHz, conducted measurement	—	-54.8	—	dBm
		Above 960 MHz, conducted measurement.	—	-77.3	—	dBm

#### 4.1.5.2.2 RF Receiver Characteristics for 802.15.4 DSSS-OQPSK in the 2.4 GHz Band

Unless otherwise indicated, typical conditions are:  $T_A = 25\text{ }^\circ\text{C}$ ,  $PAVDD = 3.0\text{V}$ ,  $AVDD = DVDD = IOVDD = RFVDD = PAVDD$ . Crystal frequency=38.4 MHz. RF center frequency 2.45 GHz. Antenna port 2.

**Table 4.15. RF Receiver Characteristics for 802.15.4 DSSS-OQPSK in the 2.4 GHz Band**

Parameter	Symbol	Test Condition	Min	Typ	Max	Unit
Max usable receiver input level, 1% PER	SAT	Signal is reference signal <sup>1</sup> , packet length is 20 octets	—	10	—	dBm
Sensitivity, 1% PER	SENS	Signal is reference signal, packet length is 20 octets	—	-104.5	—	dBm
Co-channel interferer rejection, 1% PER	CCR	Desired signal 3 dB above sensitivity limit	—	-0.2	—	dB
Adjacent channel rejection, Interferer is reference signal, 1% PER, desired is reference signal at 3 dB above reference sensitivity level <sup>2</sup>	ACR <sub>REF1</sub>	Interferer is reference signal at +1 channel spacing	—	39.9	—	dB
		Interferer is reference signal at -1 channel spacing	—	39.2	—	dB
Alternate channel rejection, interferer is reference signal, 1% PER, desired is reference signal at 3 dB above reference sensitivity level <sup>2</sup>	ACR <sub>REF2</sub>	Interferer is reference signal at +2 channel spacing	—	51.1	—	dB
		Interferer is reference signal at -2 channel spacing	—	51.6	—	dB
Image rejection, 1% PER, desired is reference signal at 3 dB above reference sensitivity level <sup>2</sup>	IR	Interferer is CW in image band <sup>3</sup>	—	43.5	—	dB
Blocking rejection of all other channels, 1% PER, desired is reference signal at 3 dB above reference sensitivity level <sup>2</sup> , interferer is reference signal	BLOCK	Interferer frequency < desired frequency -3 channel spacing	—	57.6	—	dB
		Interferer frequency > desired frequency +3 channel spacing	—	57.5	—	dB
RSSI resolution	RSSI <sub>RES</sub>	-100 dBm to +5 dBm	—	0.25	—	dB
RSSI accuracy in the linear region as defined by 802.15.4-2003	RSSI <sub>LIN</sub>		—	+/-6	—	dB

**Note:**

- Reference signal is defined as O-QPSK DSSS per 802.15.4, Frequency range = 2400-2483.5 MHz, Symbol rate = 62.5 ksymbs/s.
- Reference sensitivity level is -85 dBm.
- Due to low-IF frequency, there is some overlap of adjacent channel and image channel bands. Adjacent channel CW blocker tests place the Interferer center frequency at the Desired frequency  $\pm 5$  MHz on the channel raster, whereas the image rejection test places the CW interferer near the image frequency of the Desired signal carrier, regardless of the channel raster.



#### 4.1.5.2.3 RF Receiver Characteristics for Bluetooth Low Energy in the 2.4 GHz Band 1 Mbps Data Rate

Unless otherwise indicated, typical conditions are:  $T_A = 25\text{ }^\circ\text{C}$ ,  $PAVDD = 3.0\text{V}$ ,  $AVDD = DVDD = IOVDD = RFVDD = PAVDD$ . Crystal frequency=38.4 MHz. RF center frequency 2.45 GHz. Antenna port 2.

**Table 4.16. RF Receiver Characteristics for Bluetooth Low Energy in the 2.4 GHz Band 1 Mbps Data Rate**

Parameter	Symbol	Test Condition	Min	Typ	Max	Unit
Max usable receiver input level	SAT	Signal is reference signal, packet length is 37 bytes <sup>1</sup>	—	10	—	dBm
Sensitivity	SENS	Signal is reference signal, 37 byte payload <sup>1</sup>	—	-97.5	—	dBm
		With non-ideal signals <sup>2 1</sup>	—	-97.1	—	dBm
Signal to co-channel interferer	$C/I_{CC}$	(see notes) <sup>1 3</sup>	—	+6.6	—	dB
$N \pm 1$ Adjacent channel selectivity	$C/I_1$	Interferer is reference signal at +1 MHz offset <sup>1 4 3 5</sup>	—	-8.3	—	dB
		Interferer is reference signal at -1 MHz offset <sup>1 4 3 5</sup>	—	-8.7	—	dB
$N \pm 2$ Alternate channel selectivity	$C/I_2$	Interferer is reference signal at +2 MHz offset <sup>1 4 3 5</sup>	—	-42.1	—	dB
		Interferer is reference signal at -2 MHz offset <sup>1 4 3 5</sup>	—	-48.9	—	dB
$N \pm 3$ Alternate channel selectivity	$C/I_3$	Interferer is reference signal at +3 MHz offset <sup>1 4 3 5</sup>	—	-42.4	—	dB
		Interferer is reference signal at -3 MHz offset <sup>1 4 3 5</sup>	—	-54.8	—	dB
Selectivity to image frequency	$C/I_{IM}$	Interferer is reference signal at image frequency with 1 MHz precision <sup>1 5</sup>	—	-42.1	—	dB
Selectivity to image frequency $\pm 1$ MHz	$C/I_{IM\_1}$	Interferer is reference signal at image frequency +1 MHz with 1 MHz precision <sup>1 5</sup>	—	-42.4	—	dB
		Interferer is reference signal at image frequency -1 MHz with 1 MHz precision <sup>1 5</sup>	—	-8.3	—	dB
Intermodulation performance	IM	$n = 3^6$	—	-23	—	dBm

**Note:**

1. 0.1% Bit Error Rate.
2. With non-ideal signals as specified in Bluetooth Test Specification RF-PHY.TS.5.0.1 section 4.7.1
3. Desired signal -67 dBm.
4. Desired frequency  $2402\text{ MHz} \leq F_c \leq 2480\text{ MHz}$ .
5. With allowed exceptions.
6. As specified in Bluetooth Core specification version 5.1, Vol 6, Part A, Section 4.4

#### 4.1.5.2.4 RF Receiver Characteristics for Bluetooth Low Energy in the 2.4 GHz Band 2 Mbps Data Rate

Unless otherwise indicated, typical conditions are:  $T_A = 25\text{ }^\circ\text{C}$ ,  $PAVDD = 3.0\text{V}$ ,  $AVDD = DVDD = IOVDD = RFVDD = PAVDD$ . Crystal frequency=38.4 MHz. RF center frequency 2.45 GHz. Antenna port 2.

**Table 4.17. RF Receiver Characteristics for Bluetooth Low Energy in the 2.4 GHz Band 2 Mbps Data Rate**

Parameter	Symbol	Test Condition	Min	Typ	Max	Unit
Max usable receiver input level	SAT	Signal is reference signal, packet length is 37 bytes <sup>1</sup>	—	10	—	dBm
Sensitivity	SENS	Signal is reference signal, 37 byte payload <sup>1</sup>	—	-94.4	—	dBm
		With non-ideal signals <sup>2 1</sup>	—	-94.3	—	dBm
Signal to co-channel interferer	$C/I_{CC}$	(see notes) <sup>1 3</sup>	—	+6.0	—	dB
$N \pm 1$ Adjacent channel selectivity	$C/I_1$	Interferer is reference signal at +2 MHz offset <sup>1 4 3 5</sup>	—	-8.0	—	dB
		Interferer is reference signal at -2 MHz offset <sup>1 4 3 5</sup>	—	-8.8	—	dB
$N \pm 2$ Alternate channel selectivity	$C/I_2$	Interferer is reference signal at +4 MHz offset <sup>1 4 3 5</sup>	—	-42.2	—	dB
		Interferer is reference signal at -4 MHz offset <sup>1 4 3 5</sup>	—	-50.3	—	dB
$N \pm 3$ Alternate channel selectivity	$C/I_3$	Interferer is reference signal at +6 MHz offset <sup>1 4 3 5</sup>	—	-54.4	—	dB
		Interferer is reference signal at -6 MHz offset <sup>1 4 3 5</sup>	—	-55.4	—	dB
Selectivity to image frequency	$C/I_{IM}$	Interferer is reference signal at image frequency with 1 MHz precision <sup>1 5</sup>	—	-8.0	—	dB
Selectivity to image frequency $\pm 1$ MHz	$C/I_{IM\_1}$	Interferer is reference signal at image frequency +2 MHz with 1 MHz precision <sup>1 5</sup>	—	-42.2	—	dB
		Interferer is reference signal at image frequency -2 MHz with 1 MHz precision <sup>1 5</sup>	—	+6.0	—	dB
Intermodulation performance	IM	$n = 3^6$	—	-22.3	—	dBm

**Note:**

1. 0.1% Bit Error Rate.
2. With non-ideal signals as specified in Bluetooth Test Specification RF-PHY.TS.5.0.1 section 4.7.1
3. Desired signal -67 dBm.
4. Desired frequency  $2402\text{ MHz} \leq F_c \leq 2480\text{ MHz}$ .
5. With allowed exceptions.
6. As specified in Bluetooth Core specification version 5.1, Vol 6, Part A, Section 4.4

#### 4.1.5.2.5 RF Receiver Characteristics for Bluetooth Low Energy in the 2.4 GHz Band 500 kbps Data Rate

Unless otherwise indicated, typical conditions are:  $T_A = 25\text{ }^\circ\text{C}$ ,  $PAVDD = 3.0\text{V}$ ,  $AVDD = DVDD = IOVDD = RFVDD = PAVDD$ . Crystal frequency=38.4 MHz. RF center frequency 2.45 GHz. Antenna port 2.

**Table 4.18. RF Receiver Characteristics for Bluetooth Low Energy in the 2.4 GHz Band 500 kbps Data Rate**

Parameter	Symbol	Test Condition	Min	Typ	Max	Unit
Max usable receiver input level	SAT	Signal is reference signal, packet length is 37 bytes <sup>1</sup>	—	10	—	dBm
Sensitivity	SENS	Signal is reference signal <sup>1</sup>	—	-100.6	—	dBm
		With non-ideal signals <sup>2 1</sup>	—	-100.0	—	dBm
Signal to co-channel interferer	$C/I_{CC}$	(see notes) <sup>1 3</sup>	—	+2.1	—	dB
$N \pm 1$ Adjacent channel selectivity	$C/I_1$	Interferer is reference signal at +1 MHz offset <sup>1 4 3 5</sup>	—	-9.0	—	dB
		Interferer is reference signal at -1 MHz offset <sup>1 4 3 5</sup>	—	-9.5	—	dB
$N \pm 2$ Alternate channel selectivity	$C/I_2$	Interferer is reference signal at +2 MHz offset <sup>1 4 3 5</sup>	—	-44.4	—	dB
		Interferer is reference signal at -2 MHz offset <sup>1 4 3 5</sup>	—	-51.9	—	dB
$N \pm 3$ Alternate channel selectivity	$C/I_3$	Interferer is reference signal at +3 MHz offset <sup>1 4 3 5</sup>	—	-44.3	—	dB
		Interferer is reference signal at -3 MHz offset <sup>1 4 3 5</sup>	—	-58.3	—	dB
Selectivity to image frequency	$C/I_{IM}$	Interferer is reference signal at image frequency with 1 MHz precision <sup>1 5</sup>	—	-44.4	—	dB
Selectivity to image frequency $\pm 1$ MHz	$C/I_{IM\_1}$	Interferer is reference signal at image frequency +1 MHz with 1 MHz precision <sup>1 5</sup>	—	-44.3	—	dB
		Interferer is reference signal at image frequency -1 MHz with 1 MHz precision <sup>1 5</sup>	—	-9.0	—	dB

**Note:**

1. 0.1% Bit Error Rate.
2. With non-ideal signals as specified in Bluetooth Test Specification RF-PHY.TS.5.0.1 section 4.7.1
3. Desired signal -72 dBm.
4. Desired frequency  $2402\text{ MHz} \leq F_c \leq 2480\text{ MHz}$ .
5. With allowed exceptions.

#### 4.1.5.2.6 RF Receiver Characteristics for Bluetooth Low Energy in the 2.4 GHz Band 125 kbps Data Rate

Unless otherwise indicated, typical conditions are:  $T_A = 25\text{ }^\circ\text{C}$ ,  $PAVDD = 3.0\text{V}$ ,  $AVDD = DVDD = IOVDD = RFVDD = PAVDD$ . Crystal frequency=38.4 MHz. RF center frequency 2.45 GHz. Antenna port 2.

**Table 4.19. RF Receiver Characteristics for Bluetooth Low Energy in the 2.4 GHz Band 125 kbps Data Rate**

Parameter	Symbol	Test Condition	Min	Typ	Max	Unit
Max usable receiver input level	SAT	Signal is reference signal, packet length is 37 bytes <sup>1</sup>	—	10	—	dBm
Sensitivity	SENS	Signal is reference signal <sup>1</sup>	—	-104.9	—	dBm
		With non-ideal signals <sup>2 1</sup>	—	-104.6	—	dBm
Signal to co-channel interferer	$C/I_{CC}$	(see notes) <sup>1 3</sup>	—	+0.8	—	dB
$N \pm 1$ Adjacent channel selectivity	$C/I_1$	Interferer is reference signal at +1 MHz offset <sup>1 4 3 5</sup>	—	-13.1	—	dB
		Interferer is reference signal at -1 MHz offset <sup>1 4 3 5</sup>	—	-13.6	—	dB
$N \pm 2$ Alternate channel selectivity	$C/I_2$	Interferer is reference signal at +2 MHz offset <sup>1 4 3 5</sup>	—	-49.5	—	dB
		Interferer is reference signal at -2 MHz offset <sup>1 4 3 5</sup>	—	-56.9	—	dB
$N \pm 3$ Alternate channel selectivity	$C/I_3$	Interferer is reference signal at +3 MHz offset <sup>1 4 3 5</sup>	—	-47.0	—	dB
		Interferer is reference signal at -3 MHz offset <sup>1 4 3 5</sup>	—	-63.1	—	dB
Selectivity to image frequency	$C/I_{IM}$	Interferer is reference signal at image frequency with 1 MHz precision <sup>1 5</sup>	—	-49.5	—	dB
Selectivity to image frequency $\pm 1$ MHz	$C/I_{IM\_1}$	Interferer is reference signal at image frequency +1 MHz with 1 MHz precision <sup>1 5</sup>	—	-47.0	—	dB
		Interferer is reference signal at image frequency -1 MHz with 1 MHz precision <sup>1 5</sup>	—	-13.1	—	dB

**Note:**

1. 0.1% Bit Error Rate.
2. With non-ideal signals as specified in Bluetooth Test Specification RF-PHY.TS.5.0.1 section 4.7.1
3. Desired signal -79 dBm.
4. Desired frequency  $2402\text{ MHz} \leq F_c \leq 2480\text{ MHz}$ .
5. With allowed exceptions.

#### 4.1.6 Flash Characteristics

**Table 4.20. Flash Characteristics**

Parameter	Symbol	Test Condition	Min	Typ	Max	Unit
Flash erase cycles before failure <sup>1</sup>	EC <sub>FLASH</sub>	T <sub>A</sub> ≤ 125 °C	10,000	—	—	cycles
Flash data retention <sup>1</sup>	RET <sub>FLASH</sub>	T <sub>A</sub> ≤ 125 °C	10	—	—	years
Program Time	t <sub>PROG</sub>	one word (32-bits)	40.2	44.0	47.9	uSec
		average per word over 128 words	9.97	10.9	11.9	uSec
Page Erase Time <sup>2</sup>	t <sub>PERASE</sub>		11.6	12.7	13.9	ms
Mass Erase Time <sup>3 4</sup>	t <sub>MERASE</sub>		11.7	12.8	14.1	ms
Page Erase Current	I <sub>ERASE</sub>	T <sub>A</sub> = 25 °C	—	—	2.13	mA
Program Current	I <sub>WRITE</sub>	T <sub>A</sub> = 25 °C	—	—	2.73	mA
Mass Erase Current	I <sub>MERASE</sub>	T <sub>A</sub> = 25 °C	—	—	2.30	mA
Flash Supply voltage during write or erase	V <sub>FLASH</sub>		1.71	—	3.8	V

**Note:**

1. Flash data retention information is published in the Quarterly Quality and Reliability Report.
2. Page Erase time is measured from setting the ERASEPAGE bit in the MSC\_WRITECMD register until the BUSY bit in the MSC-STATUS register is cleared to 0. Internal set-up and hold times are included.
3. Mass Erase is issued by the CPU and erases all of User space.
4. Mass Erase time is measured from setting the ERASEMAIN0 bit in the MSC\_WRITECMD register until the BUSY bit in the MSC-STATUS register is cleared to 0. Internal set-up and hold times are included.

#### 4.1.7 Wake Up, Entry, and Exit times

Unless otherwise specified, these times are measured using the HFRCO at 19 MHz.

**Table 4.21. Wake Up, Entry, and Exit times**

Parameter	Symbol	Test Condition	Min	Typ	Max	Unit
WakeupTime from EM1	t <sub>EM1_WU</sub>	Code execution from flash	—	3	—	AHB Clocks
		Code execution from RAM	—	1.43	—	µs
WakeupTime from EM2	t <sub>EM2_WU</sub>	Code execution from flash	—	12.2	—	µs
		Code execution from RAM	—	3.92	—	µs
		Code execution from flash @ 80 MHz	—	9.00	—	µs
		Code execution from RAM @ 80 MHz	—	2.87	—	µs
WakeupTime from EM3	t <sub>EM3_WU</sub>	Code execution from flash	—	12.2	—	µs
		Code execution from RAM	—	3.92	—	µs
		Code execution from flash @ 80 MHz	—	9.00	—	µs
		Code execution from RAM @ 80 MHz	—	2.87	—	µs
WakeupTime from EM4	t <sub>EM4_WU</sub>	Code execution from Flash	—	17.8	—	ms
Entry time to EM1	t <sub>EM1_ENT</sub>	Code execution from flash	—	1.52	—	µs
Entry time to EM2	t <sub>EM2_ENT</sub>	Code execution from flash	—	74.0	—	µs
Entry time to EM3	t <sub>EM3_ENT</sub>	Code execution from flash	—	74.0	—	µs
Entry time to EM4	t <sub>EM4_ENT</sub>	Code execution from flash	—	84.1	—	µs

## 4.1.8 Oscillators

### 4.1.8.1 High Frequency Crystal Oscillator

Unless otherwise indicated, typical conditions are: AVDD = DVDD = RFVDD = 3.0 V. T<sub>A</sub> = 25 °C. Minimum and maximum values in this table represent the worst conditions across process variation, operating supply voltage range, and operating temperature range.

**Table 4.22. High Frequency Crystal Oscillator**

Parameter	Symbol	Test Condition	Min	Typ	Max	Unit
Crystal Frequency	F <sub>HFXO</sub>	see note <sup>1 2</sup>	—	38.4	—	MHz
Supported crystal equivalent series resistance (ESR)	ESR <sub>HFXO_38M4</sub>	38.4 MHz, CL = 10 pF <sup>3</sup>	—	—	40	Ω
Supported range of crystal load capacitance	C <sub>HFXO_LC</sub>	38.4 MHz, ESR = 40 <sup>4</sup>	—	10	—	pF
Supply Current	I <sub>HFXO</sub>		—	500	—	μA
Startup Time	T <sub>STARTUP</sub>	38.4 MHz, ESR=40 Ohm, CL=10 pF	—	160	—	μs
On-chip tuning cap step size <sup>5</sup>	SS <sub>HFXO</sub>		—	0.04	—	pF

**Note:**

1. The BLE radio requires a 38.4 MHz crystal with a tolerance of ± 50 ppm over temperature and aging. Please use the recommended crystal.
2. The ZigBee radio requires a 38.4 MHz crystal with a tolerance of ± 40 ppm over temperature and aging. Please use the recommended crystal.
3. The crystal should have a maximum ESR less than or equal to this maximum rating.
4. It is recommended to use a crystal with a 10 pF load capacitance rating. Only crystals with a 10 pF load cap rating have been characterized for RF use.
5. The tuning step size is the effective step size when incrementing one of the tuning capacitors by one count. The step size for the each of the individual tuning capacitors is twice this value.

#### 4.1.8.2 Low Frequency Crystal Oscillator

**Table 4.23. Low Frequency Crystal Oscillator**

Parameter	Symbol	Test Condition	Min	Typ	Max	Unit
Crystal Frequency	$F_{LFXO}$		—	32.768	—	kHz
Supported Crystal equivalent series resistance (ESR)	$ESR_{LFXO}$	GAIN=0	—	—	80	k $\Omega$
		GAIN=1 to 3	—	—	100	k $\Omega$
Supported range of crystal load capacitance <sup>1</sup>	$C_{LFXO\_CL}$	GAIN = 0	4	—	6	pF
		GAIN = 1	6	—	10	pF
		GAIN = 2	10	—	12.5	pF
		GAIN = 3 <sup>2</sup>	12.5	—	18	pF
Current consumption	$I_{CL12p5}$	ESR = 70 k $\Omega$ , CL = 12.5 pF, GAIN <sup>3</sup> = 2, AGC <sup>4</sup> = 1	—	357	—	nA
Startup Time	$T_{STARTUP}$	ESR = 70k $\Omega$ , CL = 7 pF, GAIN <sup>3</sup> = 1, AGC <sup>4</sup> = 1	—	63	—	ms
On-chip tuning cap step size	$SS_{LFXO}$		—	0.26	—	pF
On-chip tuning capacitor value at minimum setting <sup>5</sup>	$C_{LFXO\_MIN}$	CAPTUNE = 0	—	4	—	pF
On-chip tuning capacitor value at maximum setting <sup>5</sup>	$C_{LFXO\_MAX}$	CAPTUNE = 0x4F	—	24.5	—	pF

**Note:**

1. Total load capacitance seen by the crystal
2. Crystals with a load capacitance of greater than 12 pF require external load capacitors.
3. In LFXO\_CAL Register
4. In LFXO\_CFG Register
5. The effective load capacitance seen by the crystal will be  $C_{LFXO}/2$ . This is because each XTAL pin has a tuning cap and the two caps will be seen in series by the crystal



### 4.1.8.3 High Frequency RC Oscillator (HFRCO)

Unless otherwise indicated, typical conditions are: AVDD = DVDD = 3.0 V. T<sub>A</sub> = 25 °C. Minimum and maximum values in this table represent the worst conditions across process variation, operating supply voltage range, and operating temperature range.

**Table 4.24. High Frequency RC Oscillator (HFRCO)**

Parameter	Symbol	Test Condition	Min	Typ	Max	Unit
Frequency Accuracy	F <sub>HFRCO_ACC</sub>	For all production calibrated frequencies	-3	—	+3	%
Current consumption on all supplies <sup>1</sup>	I <sub>HFRCO</sub>	F <sub>HFRCO</sub> = 1 MHz	—	27	—	μA
		F <sub>HFRCO</sub> = 2 MHz	—	27	—	μA
		F <sub>HFRCO</sub> = 4 MHz	—	27	—	μA
		F <sub>HFRCO</sub> = 7 MHz	—	59	—	μA
		F <sub>HFRCO</sub> = 13 MHz	—	77	—	μA
		F <sub>HFRCO</sub> = 16 MHz	—	87	—	μA
		F <sub>HFRCO</sub> = 19 MHz	—	90	—	μA
		F <sub>HFRCO</sub> = 26 MHz	—	116	—	μA
		F <sub>HFRCO</sub> = 32 MHz	—	139	—	μA
		F <sub>HFRCO</sub> = 38 MHz <sup>2</sup>	—	170	—	μA
		F <sub>HFRCO</sub> = 40 MHz <sup>3</sup>	—	172	—	μA
		F <sub>HFRCO</sub> = 48 MHz <sup>2</sup>	—	207	—	μA
		F <sub>HFRCO</sub> = 56 MHz <sup>2</sup>	—	228	—	μA
		F <sub>HFRCO</sub> = 64 MHz <sup>2</sup>	—	269	—	μA
F <sub>HFRCO</sub> = 80 MHz <sup>2</sup>	—	285	—	μA		
Clock out current for HFRCODPLL <sup>4</sup>	I <sub>CLKOUT_HFRCODPLL</sub>	FORECEEN bit of HFRCO0_CTRL = 1	—	3.0	—	μA/MHz
Clock Out current for HFRCOEM23 <sup>4</sup>	I <sub>CLKOUT_HFRCOEM23</sub>	FORECEEN bit of HFRCOEM23_CTRL = 1	—	1.6	—	μA/MHz
Coarse trim step Size (% of period)	SS <sub>HFRCO_COARSE</sub>	Step size measured at coarse trim mid-scale. (Fine trim also set to mid scale.)	—	0.64	—	%
Fine trim step Size (% of period)	SS <sub>HFRCO_FINE</sub>	Step size measured at fine trim mid-scale. (Coarse trim also set to mid scale.)	—	0.1	—	%
Period jitter	PJ <sub>HFRCO</sub>	19 MHz	—	0.04	—	% RMS
Startup Time <sup>5</sup>	T <sub>STARTUP</sub>	FREQRANGE = 0 to 7	—	3.2	—	μs
		FREQRANGE = 8 to 15	—	1.2	—	μs

Parameter	Symbol	Test Condition	Min	Typ	Max	Unit
Band Frequency Limits <sup>6</sup>	f <sub>HFRCO_BAND</sub>	FREQRANGE=0	3.71	—	5.24	MHz
		FREQRANGE=1	4.39	—	6.26	MHz
		FREQRANGE=2	5.25	—	7.55	MHz
		FREQRANGE=3	6.22	—	9.01	MHz
		FREQRANGE=4	7.88	—	11.6	MHz
		FREQRANGE=5	9.9	—	14.6	MHz
		FREQRANGE=6	11.5	—	17.0	MHz
		FREQRANGE=7	14.1	—	20.9	MHz
		FREQRANGE=8	16.4	—	24.7	MHz
		FREQRANGE=9	19.8	—	30.4	MHz
		FREQRANGE=10	22.7	—	34.9	MHz
		FREQRANGE=11	28.6	—	44.4	MHz
		FREQRANGE=12	33.0	—	51.0	MHz
		FREQRANGE=13	42.2	—	64.6	MHz
		FREQRANGE=14	48.8	—	74.8	MHz
FREQRANGE=15	57.6	—	87.4	MHz		

**Note:**

1. Does not include additional clock tree current. See specifications for additional current when selected as a clock source for a particular clock multiplexer.
2. This frequency is calibrated for the HFRCODPLL only.
3. This frequency is calibrated for the HFRCOEM23 only.
4. When the HFRCO is enabled for characterization using the FORCEEN bit, the total current will be the HFRCO core current plus the specified CLKOUT current. When the HFRCO is enabled on demand, the clock current may be different.
5. Hardware delay ensures setting to within +/-0.5%. Hardware also enforces this delay on a band change.
6. The frequency band limits represent the lowest and highest frequency which each band can achieve over the operating range.

#### 4.1.8.4 Fast Start\_Up RC Oscillator (FSRCO)

**Table 4.25. Fast Start\_Up RC Oscillator (FSRCO)**

Parameter	Symbol	Test Condition	Min	Typ	Max	Unit
FSRCO frequency	FREQ <sub>FSRCO</sub>		17.2	20	21.2	MHz

#### 4.1.8.5 Low Frequency RC Oscillator

**Table 4.26. Low Frequency RC Oscillator**

Parameter	Symbol	Test Condition	Min	Typ	Max	Unit
Nominal oscillation frequency	$F_{\text{LFRCO}}$		31.785	32.768	33.751	kHz
Frequency calibration step	$F_{\text{TRIM\_STEP}}$	Typical trim step at mid-scale	—	0.33	—	%
Startup time	$T_{\text{STARTUP}}$		—	220	—	$\mu\text{s}$
Current consumption	$I_{\text{LFRCO}}$		—	186	—	nA

#### 4.1.8.6 Ultra Low Frequency RC Oscillator

**Table 4.27. Ultra Low Frequency RC Oscillator**

Parameter	Symbol	Test Condition	Min	Typ	Max	Unit
Oscillation Frequency	$F_{\text{ULFRCO}}$		0.944	1.0	1.095	kHz

#### 4.1.9 GPIO Pins (3V GPIO pins)

Unless otherwise indicated, typical conditions are: AVDD = DVDD = IOVDD = 3.0 V.

**Table 4.28. GPIO Pins (3V GPIO pins)**

Parameter	Symbol	Test Condition	Min	Typ	Max	Unit
Leakage current	I <sub>LEAK_IO</sub>	MODEx = DISABLED, IOVDD = 1.71V	—	1.9	—	nA
		MODEx = DISABLED, IOVDD = 3.0 V	—	2.5	—	nA
		MODEx = DISABLED, IOVDD = 3.8 V T <sub>A</sub> = 125 °C	—	—	200	nA
Input low voltage <sup>1</sup>	V <sub>IL</sub>	Any GPIO pin	—	—	0.3*IOVDD	V
Input high voltage <sup>1</sup>	V <sub>IH</sub>	Any GPIO pin	0.7*IOVDD	—	—	V
Output low voltage	V <sub>OL</sub>	Sinking 20mA, IOVDD = 3.0 V	—	—	0.2 * IOVDD	V
		Sinking 8mA, IOVDD = 1.62 V	—	—	0.4 * IOVDD	V
Output high voltage	V <sub>OH</sub>	Sourcing 20mA, IOVDD = 3.0 V	0.8 * IOVDD	—	—	V
		Sourcing 8mA, IOVDD = 1.62 V	0.6 * IOVDD	—	—	V
GPIO rise time	T <sub>GPIO_RISE</sub>	IOVDD = 3.0V, C <sub>load</sub> = 50pF, SLEWRATE = 4, 10% to 90%	—	8.4	—	ns
		IOVDD = 1.7V, C <sub>load</sub> = 50pF, SLEWRATE = 4, 10% to 90%	—	13	—	ns
GPIO fall time	T <sub>GPIO_FALL</sub>	IOVDD = 3.0V, C <sub>load</sub> = 50pF, SLEWRATE = 4, 90% to 10%	—	7.1	—	ns
		IOVDD = 1.7V, C <sub>load</sub> = 50pF, SLEWRATE = 4, 90% to 10%	—	11.9	—	ns
Pull up/down resistance <sup>2</sup>	R <sub>PULL</sub>	pull-up: MODEn = DISABLE DOUT=1, pull-down: MODEn = WIREDORPULLDOWN DOUT = 0	35	44	55	kΩ
Maximum filtered glitch width	T <sub>GF</sub>	MODE = INPUT, DOUT = 1	—	26	—	ns

**Note:**

1. GPIO input thresholds are proportional to the IOVDD pin. RESETn input thresholds are proportional to DVDD.
2. GPIO pull-ups connect to IOVDD supply, pull-downs connect to VSS. RESETn pull-up connects to DVDD.

#### 4.1.10 Analog to Digital Converter (ADC)

Unless otherwise indicated, typical conditions are: ADCCLK=10 MHz, OSR=2

**Table 4.29. Analog to Digital Converter (ADC)**

Parameter	Symbol	Test Condition	Min	Typ	Max	Unit
Main analog supply	V <sub>AVDD</sub>	Normal mode	1.71	—	3.8	V
Maximum Input Range	V <sub>IN_MAX</sub>	Maximum allowable input voltage	0	—	AVDD	V
Full-Scale Voltage	V <sub>FS</sub>	Voltage required for Full-Scale measurement	—	V <sub>REF</sub> / Gain	—	
Input Measurement Range	V <sub>IN</sub>	Differential Mode - Plus and Minus inputs	-V <sub>FS</sub>	—	+V <sub>FS</sub>	V
		Single Ended Mode - One input tied to ground	0	—	V <sub>FS</sub>	V
Input Sampling Capacitance	C <sub>s</sub>	Analog Gain = 1x	—	1.8	—	pF
		Analog Gain = 2x	—	3.6	—	pF
		Analog Gain = 4x.	—	7.2	—	pF
		Analog Gain =0.5x	—	0.9	—	pF
ADC clock frequency	f <sub>CLK</sub>	(1 Mbps)	—	—	10	MHz
Throughput rate	f <sub>SAMPLE</sub>	f <sub>CLK</sub> = 10 MHz	—	—	1	MspS
Current from all supplies, Continuous operation	I <sub>ADC_CONTINUOUS</sub>	1 MspS, OSR=2, f <sub>CLK</sub> = 10 MHz	—	290	385	μA
Current in Standby mode. ADC is not functional but can wake up in 1us.	I <sub>STBY</sub>	Normal Mode	—	16.3	—	μA
ADC Startup Time	t <sub>startup</sub>	From power down state	—	5	—	μS
		From Standby state	—	1	—	μS
ADC Resolution	Resolution	Max value is at OSR=64	—	12	—	bits
Differential Nonlinearity	DNL	Differential Input. (No missing codes)	-1	+/- 0.25	+1.5	LSB12
Integral Nonlinearity	INL	Differential Input.	-2.5	+/- 0.65	-+2.5	LSB12
Effective number of bits	ENOB	Differential Input. Gain=1x, f <sub>IN</sub> = 10 kHz, Internal VREF=1.21V.	10.5	11.18	—	bits
Signal to Noise + Distortion Ratio Normal Mode	SNDR	Differential Input. Gain=1x, f <sub>IN</sub> = 10 kHz, Internal VREF=1.21V	65	69.1	—	dB
		Differential Input. Gain=2x, f <sub>IN</sub> = 10 kHz, Internal VREF=1.21V	—	68.8	—	dB
		Differential Input. Gain=4x, f <sub>IN</sub> = 10 kHz, Internal VREF=1.21V	—	66.9	—	dB
		Differential Input. Gain=0.5x, f <sub>IN</sub> = 10 kHz, Internal VREF=1.21V	—	69.2	—	dB
Total Harmonic Distortion	THD	Differential Input. Gain=1x, f <sub>IN</sub> =10 kHz, Internal VREF=1.21V	—	-80.3	-70	dB

Parameter	Symbol	Test Condition	Min	Typ	Max	Unit
Spurious-Free Dynamic Range	SFDR	Differential Input. Gain=1x, $f_{IN} = 10$ kHz, Internal VREF=1.21V	72	86.5	—	dB
Common Mode Rejection Ratio	CMRR	Normal mode. DC to 100 Hz	—	87.0	—	dB
		Normal mode. AC (measured at 500 kHz)	—	68.6	—	dB
Power Supply Rejection Ratio	PSRR	DC to 100 Hz	—	80.4	—	dB
		AC high frequency, using VREF_pad (measured at 500 kHz)	—	33.4	—	dB
		AC high frequency, using internal VBGR (measured at 500 kHz)	—	65.2	—	dB
Gain Error	GE	GAIN=1 and 0.5, using external VREF, direct mode.	-0.3	0.069	0.3	%
		GAIN=2, using external VREF, direct mode.	-0.4	0.151	0.4	%
		GAIN=3, using external VREF, direct mode.	-0.7	0.186	0.7	%
		GAIN=4, using external VREF, direct mode.	-1.1	0.227	1.1	%
		Internal VREF, Gain=1	—	0.023	—	%
Offset	OFFSET	GAIN=1 and 0.5, Differential Input	-3	0.27	3	LSB
		GAIN=2, Differential Input	-4	0.27	4	LSB
		GAIN=3, Differential Input	-4	0.25	4	LSB
		GAIN=4, Differential Input	-4	0.29	4	LSB
External reference voltage range	V <sub>EVREF</sub>		1.0	—	AVDD	V
Internal Reference voltage	V <sub>IVREF</sub>		—	1.21	—	V

### 4.1.11 Analog Comparator (ACMP)

**Table 4.30. Analog Comparator (ACMP)**

Parameter	Symbol	Test Condition	Min	Typ	Max	Unit
ACMP Supply current from AVDD pin	$I_{ACMP}$	BIAS = 4, HYST = DISABLED	—	4.17	—	$\mu\text{A}$
		BIAS = 5, HYST = DISABLED	—	8.96	—	$\mu\text{A}$
		BIAS = 6, HYST = DISABLED	—	23.1	—	$\mu\text{A}$
		BIAS = 7, HYST = DISABLED	—	43.9	70	$\mu\text{A}$
ACMP Supply current from AVDD pin with Hysteresis	$I_{ACMP\_WHYS}$	BIAS = 4, HYST = SYM30MV	—	5.98	—	$\mu\text{A}$
		BIAS = 5, HYST = SYM30MV	—	13.0	—	$\mu\text{A}$
		BIAS = 6, HYST = SYM30MV	—	33.6	—	$\mu\text{A}$
		BIAS = 7, HYST = SYM30MV	—	64.2	—	$\mu\text{A}$
Current Consumption of Internal Voltage Reference	$I_{ACMPREF}$	BIASPROG = 7	—	—	—	$\mu\text{A}$
Comparator delay with 100mV overdrive	$T_{DELAY}$	BIAS = 4	—	155	—	ns
		BIAS = 5	—	86.6	—	ns
		BIAS = 6	—	50.6	—	ns
		BIAS = 7	—	39.9	—	ns
Input offset voltage	$V_{OFFSET}$	BIAS = 4, $V_{CM} = 0.15$ to AVDD - 0.15	-25	—	+25	mV
		BIAS = 7, $V_{CM} = 0.15$ to AVDD - 0.15	-30	—	+30	mV
Input Range	$V_{IN}$	Input Voltage Range	0	—	AVDD	V
Hysteresis (BIAS = 4)	$V_{HYST}$	HYST = SYM10MV <sup>1</sup>	—	21.2	—	mV
		HYST = SYM20MV <sup>1</sup>	—	39.9	—	mV
		HYST = SYM30MV <sup>1</sup>	—	57.6	—	mV
Reference Voltage	$V_{ACMPREF}$	Internal 1.25 V Reference	1.19	1.25	1.31	V
		Internal 2.5 V Reference	2.34	2.5	2.75	V
Capacitive Sense Oscillator Resistance	$R_{CSRESSEL}$	CSRESSEL = 0	—	14	—	k $\Omega$
		CSRESSEL = 1	—	24	—	k $\Omega$
		CSRESSEL = 2	—	43	—	k $\Omega$
		CSRESSEL = 3	—	60	—	k $\Omega$
		CSRESSEL = 4	—	80	—	k $\Omega$
		CSRESSEL = 5	—	99	—	k $\Omega$
		CSRESSEL = 6	—	120	—	k $\Omega$

**Note:**

1.  $V_{CM} = 1.25$  V

#### 4.1.12 Temperature Sense

**Table 4.31. Temperature Sense**

Parameter	Symbol	Test Condition	Min	Typ	Max	Unit
Temperature sensor range	T <sub>sense_range</sub>		-40	—	125	°C
Temperature sensor resolution	T <sub>senseRes</sub>		—	0.25	—	°C



#### 4.1.13 Brown Out Detectors

##### 4.1.13.1 DVDD BOD

BOD Thresholds on DVDD in EM0 and EM1 only, unless otherwise noted. Typical conditions are at  $T_A = 25\text{ }^\circ\text{C}$ . Minimum and maximum values in this table represent the worst conditions across process variation, operating supply voltage range, and operating temperature range.

**Table 4.32. DVDD BOD**

Parameter	Symbol	Test Condition	Min	Typ	Max	Unit
BOD threshold	$V_{DVDD\_BOD}$	Supply Rising	—	1.67	1.71	V
		Supply Falling	1.62	1.65	—	V
BOD response time	$t_{DVDD\_BOD\_DELAY}$	Supply dropping at 100mV/ $\mu$ s slew rate <sup>1</sup>	—	0.95	—	$\mu$ s
BOD hysteresis	$V_{DVDD\_BOD\_HYS T}$		—	20	—	mV

**Note:**

1. If the supply slew rate exceeds the specified slew rate, the BOD may trip later than expected (at a threshold below the minimum specified threshold), or the BOD may not trip at all (e.g., if the supply ramps down and then back up at a very fast rate)

##### 4.1.13.2 LE DVDD BOD

BOD thresholds on DVDD pin for low energy modes EM2 to EM4, unless otherwise noted.

**Table 4.33. LE DVDD BOD**

Parameter	Symbol	Test Condition	Min	Typ	Max	Unit
BOD threshold	$V_{DVDD\_LE\_BOD}$	Supply Falling	1.5	—	1.71	V
BOD response time	$t_{DVDD\_LE\_BOD\_DELAY}$	Supply dropping at 2mV/ $\mu$ s slew rate <sup>1</sup>	—	50	—	$\mu$ s
BOD hysteresis	$V_{DVDD\_LE\_BOD\_HYST}$		—	20	—	mV

**Note:**

1. If the supply slew rate exceeds the specified slew rate, the BOD may trip later than expected (at a threshold below the minimum specified threshold), or the BOD may not trip at all (e.g., if the supply ramps down and then back up at a very fast rate)

### 4.1.13.3 AVDD and VIO BODs

BOD Thresholds for AVDD BOD and BOD for VIO supply or supplies. All energy modes.

**Table 4.34. AVDD and VIO BODs**

Parameter	Symbol	Test Condition	Min	Typ	Max	Unit
BOD threshold	$V_{BOD}$	Supply falling	1.45	—	1.71	V
BOD response time	$t_{BOD\_DELAY}$	Supply dropping at 2mV/ $\mu$ s slew rate <sup>1</sup>	—	50	—	$\mu$ s
BOD hysteresis	$V_{BOD\_HYST}$		—	20	—	mV

**Note:**

1. If the supply slew rate exceeds the specified slew rate, the BOD may trip later than expected (at a threshold below the minimum specified threshold), or the BOD may not trip at all (e.g., if the supply ramps down and then back up at a very fast rate)

#### 4.1.14 SPI Electrical Specifications

##### 4.1.14.1 SPI Master Timing

Table 4.35. SPI Master Timing

Parameter	Symbol	Test Condition	Min	Typ	Max	Unit
SCLK period <sup>1 2 3</sup>	t <sub>SCLK</sub>		2*t <sub>HFFPERCLK</sub>	—	—	ns
CS to MOSI <sup>1 2</sup>	t <sub>CS_MO</sub>		-18.5	—	22.5	ns
SCLK to MOSI <sup>1 2</sup>	t <sub>SCLK_MO</sub>		-13	—	11	ns
MISO setup time <sup>1 2</sup>	t <sub>SU_MI</sub>	IOVDD = 1.62 V	44	—	—	ns
		IOVDD = 3.0 V	34	—	—	ns
MISO hold time <sup>1 2</sup>	t <sub>H_MI</sub>		-8.5	—	—	ns

**Note:**

1. Applies for both CLKPHA = 0 and CLKPHA = 1
2. Measurement done with 8 pF output loading at 10% and 90% of V<sub>DD</sub>.
3. t<sub>HFFPERCLK</sub> is one period of the selected HFFPERCLK.

##### 4.1.14.2 SPI Slave Timing

Table 4.36. SPI Slave Timing

Parameter	Symbol	Test Condition	Min	Typ	Max	Unit
SCLK period <sup>1 2 3</sup>	t <sub>SCLK</sub>		6*t <sub>HFFPERCLK</sub>	—	—	ns
SCLK high time <sup>1 2 3</sup>	t <sub>SCLK_HI</sub>		2.5*t <sub>HFFPERCLK</sub>	—	—	ns
SCLK low time <sup>1 2 3</sup>	t <sub>SCLK_LO</sub>		2.5*t <sub>HFFPERCLK</sub>	—	—	ns
CS active to MISO <sup>1 2</sup>	t <sub>CS_ACT_MI</sub>		16	—	52.5	ns
CS disable to MISO <sup>1 2</sup>	t <sub>CS_DIS_MI</sub>		15	—	46	ns
MOSI setup time <sup>1 2</sup>	t <sub>SU_MO</sub>		3.5	—	—	ns
MOSI hold time <sup>1 2 3</sup>	t <sub>H_MO</sub>		4.5	—	—	ns
SCLK to MISO <sup>1 2 3</sup>	t <sub>SCLK_MI</sub>		13.5 + 1.5*t <sub>HFFPERCLK</sub>	—	31 + 2.5*t <sub>HFFPERCLK</sub>	ns

**Note:**

1. Applies for both CLKPHA = 0 and CLKPHA = 1 (figure only shows CLKPHA = 0).
2. Measurement done with 8 pF output loading at 10% and 90% of V<sub>DD</sub> (figure shows 50% of V<sub>DD</sub>).
3. t<sub>HFFPERCLK</sub> is one period of the selected HFFPERCLK.

## 4.1.15 I2C Electrical Specifications

### 4.1.15.1 I2C Standard-mode (Sm)

CLHR set to 0 in the I2Cn\_CTRL register.

Table 4.37. I2C Standard-mode (Sm)

Parameter	Symbol	Test Condition	Min	Typ	Max	Unit
SCL clock frequency <sup>1</sup>	$f_{SCL}$		0	—	100	kHz
SCL clock low time	$t_{LOW}$		4.7	—	—	$\mu$ s
SCL clock high time	$t_{HIGH}$		4	—	—	$\mu$ s
SDA set-up time	$t_{SU\_DAT}$		250	—	—	ns
SDA hold time	$t_{HD\_DAT}$		0	—	—	ns
Repeated START condition set-up time	$t_{SU\_STA}$		4.7	—	—	$\mu$ s
Repeated START condition hold time	$t_{HD\_STA}$		4.0	—	—	$\mu$ s
STOP condition set-up time	$t_{SU\_STO}$		4.0	—	—	$\mu$ s
Bus free time between a STOP and START condition	$t_{BUF}$		4.7	—	—	$\mu$ s

**Note:**

1. The maximum SCL clock frequency listed is assuming that an arbitrary clock frequency is available. The maximum attainable SCL clock frequency may be slightly less using the HFXO or HFRCO due to the limited frequencies available. The CLKDIV should be set to a value that keeps the SCL clock frequency below the max value listed.

#### 4.1.15.2 I2C Fast-mode (Fm)

CLHR set to 1 in the I2Cn\_CTRL register.

**Table 4.38. I2C Fast-mode (Fm)**

Parameter	Symbol	Test Condition	Min	Typ	Max	Unit
SCL clock frequency <sup>1</sup>	$f_{SCL}$		0	—	400	kHz
SCL clock low time	$t_{LOW}$		1.3	—	—	$\mu s$
SCL clock high time	$t_{HIGH}$		0.6	—	—	$\mu s$
SDA set-up time	$t_{SU\_DAT}$		100	—	—	ns
SDA hold time	$t_{HD\_DAT}$		0	—	—	ns
Repeated START condition set-up time	$t_{SU\_STA}$		0.6	—	—	$\mu s$
Repeated START condition hold time	$t_{HD\_STA}$		0.6	—	—	$\mu s$
STOP condition set-up time	$t_{SU\_STO}$		0.6	—	—	$\mu s$
Bus free time between a STOP and START condition	$t_{BUF}$		1.3	—	—	$\mu s$

**Note:**

1. The maximum SCL clock frequency listed is assuming that an arbitrary clock frequency is available. The maximum attainable SCL clock frequency may be slightly less using the HFXO or HFRCO due to the limited frequencies available. The CLKDIV should be set to a value that keeps the SCL clock frequency below the max value listed.

### 4.1.15.3 I2C Fast-mode Plus (Fm+)

CLHR set to 1 in the I2Cn\_CTRL register.

**Table 4.39. I2C Fast-mode Plus (Fm+)**

Parameter	Symbol	Test Condition	Min	Typ	Max	Unit
SCL clock frequency <sup>1</sup>	$f_{SCL}$		0	—	1000	kHz
SCL clock low time	$t_{LOW}$		0.5	—	—	$\mu s$
SCL clock high time	$t_{HIGH}$		0.26	—	—	$\mu s$
SDA set-up time	$t_{SU\_DAT}$		50	—	—	ns
SDA hold time	$t_{HD\_DAT}$		0	—	—	ns
Repeated START condition set-up time	$t_{SU\_STA}$		0.26	—	—	$\mu s$
Repeated START condition hold time	$t_{HD\_STA}$		0.26	—	—	$\mu s$
STOP condition set-up time	$t_{SU\_STO}$		0.26	—	—	$\mu s$
Bus free time between a STOP and START condition	$t_{BUF}$		0.5	—	—	$\mu s$

**Note:**

1. The maximum SCL clock frequency listed is assuming that an arbitrary clock frequency is available. The maximum attainable SCL clock frequency may be slightly less using the HFXO or HFRCO due to the limited frequencies available. The CLKDIV should be set to a value that keeps the SCL clock frequency below the max value listed.

## 4.2 Typical Performance Curves

Typical performance curves indicate typical characterized performance under the stated conditions.

### 4.2.1 Supply Current

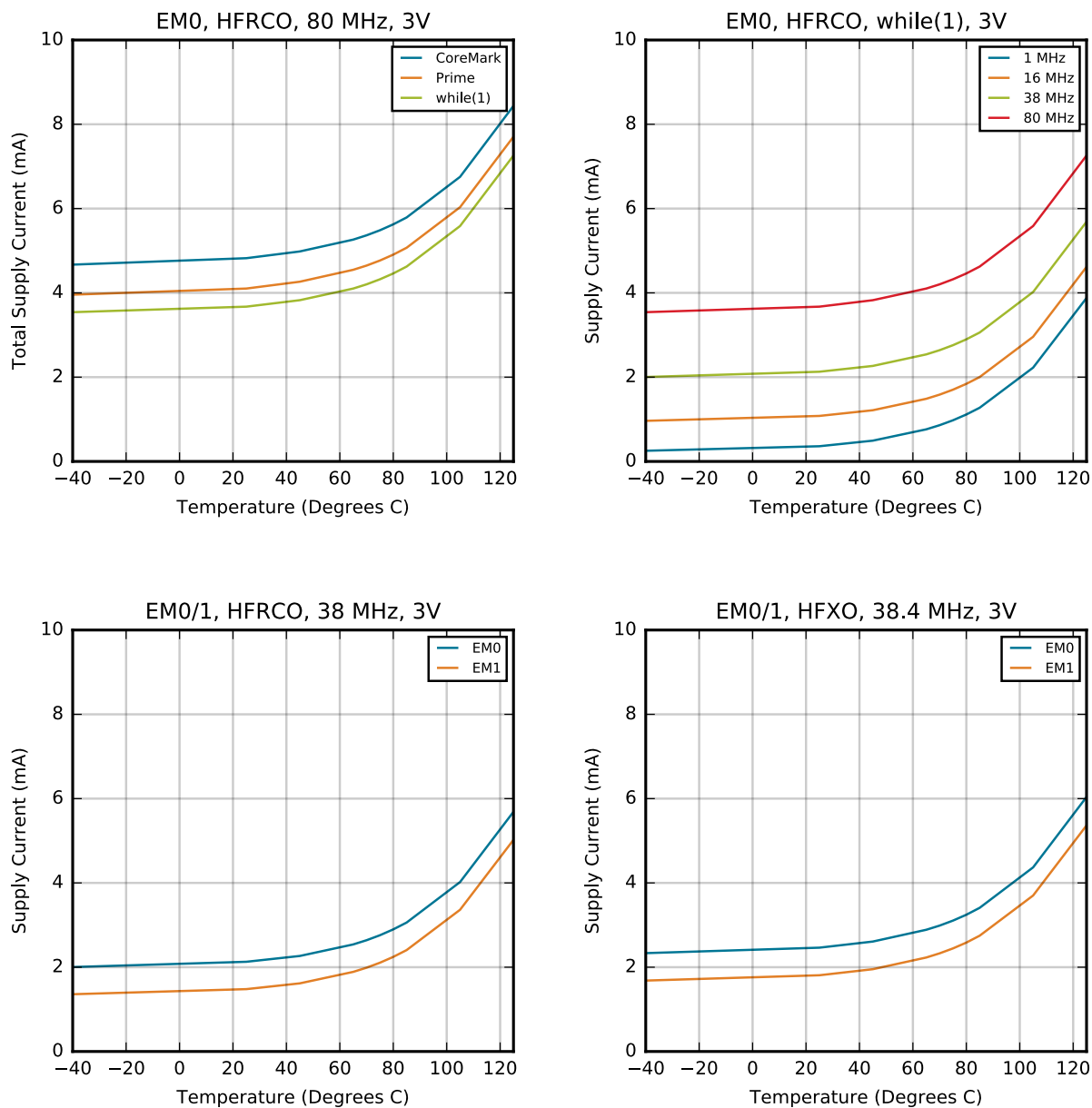

Figure 4.1. EM0 Active Mode Typical Supply Current vs. Temperature

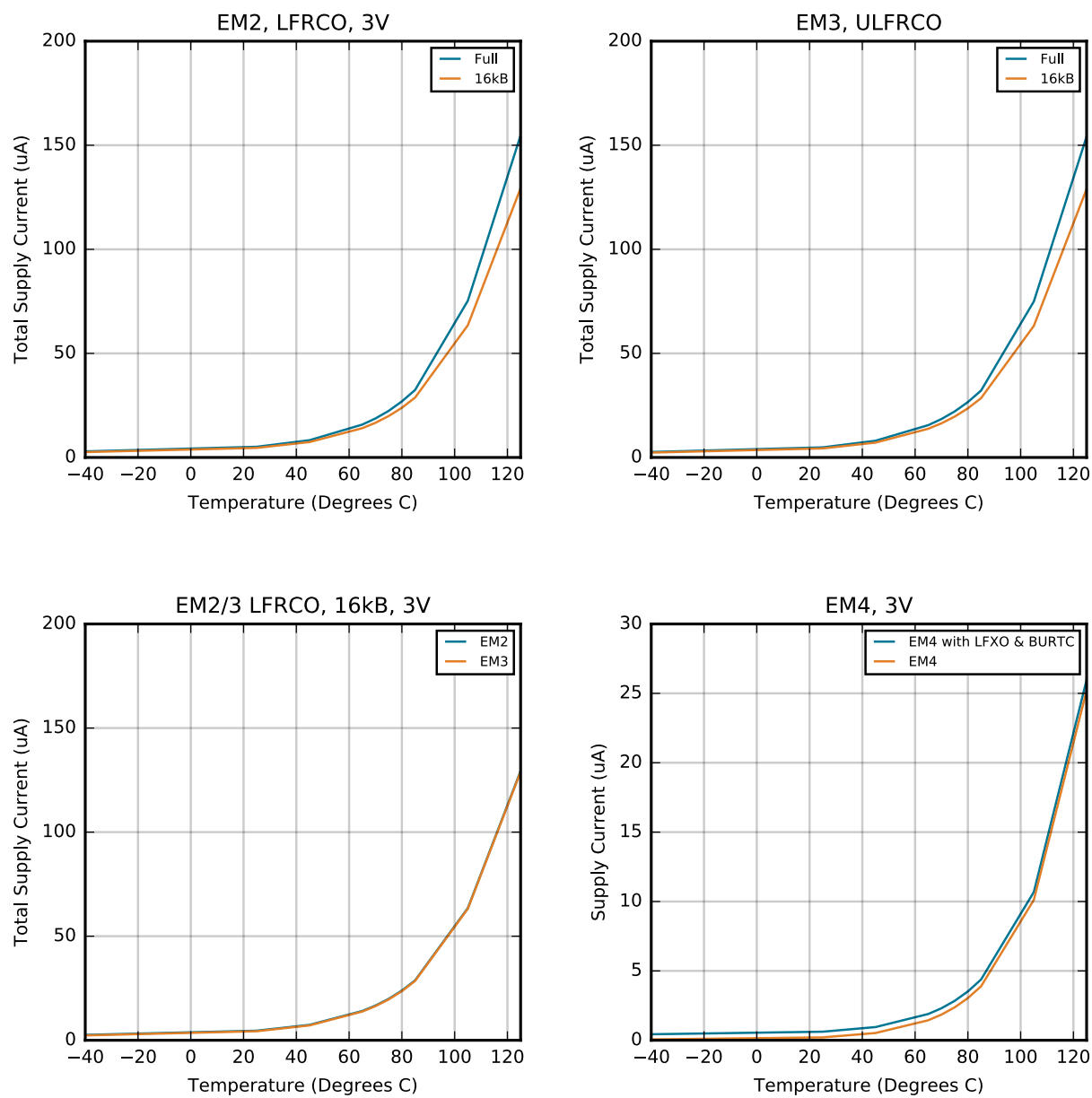

Figure 4.2. EM2, EM3, and EM4 Sleep Mode Typical Supply Current vs. Temperature



4.2.2 2.4 GHz Radio

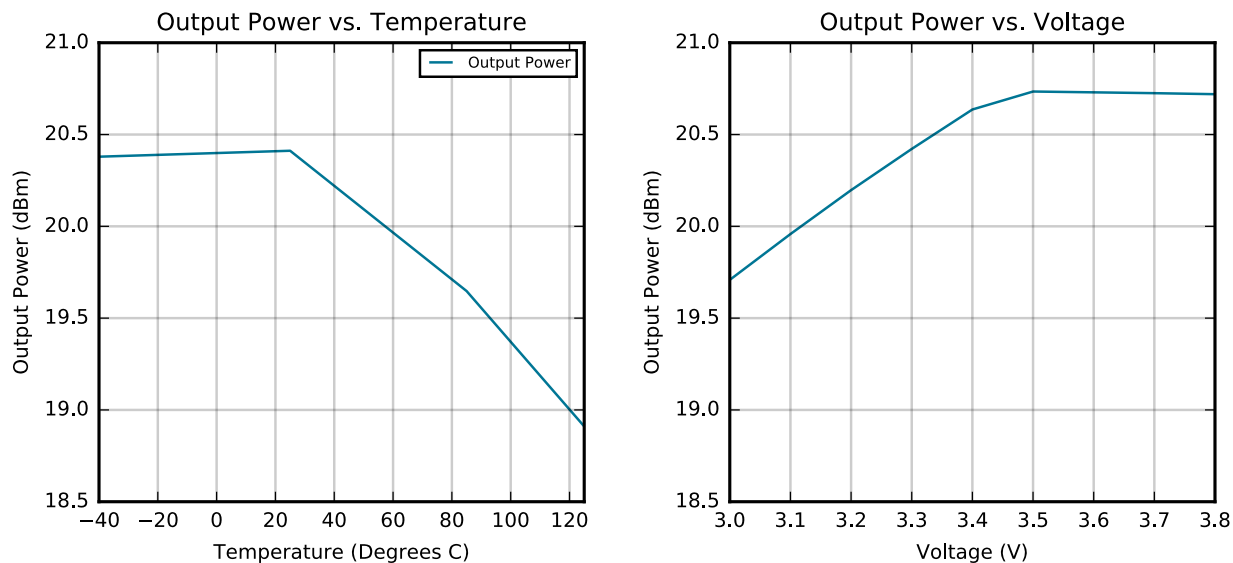

Figure 4.3. 2.4 GHz 20 dBm PA RF Transmitter Output Power

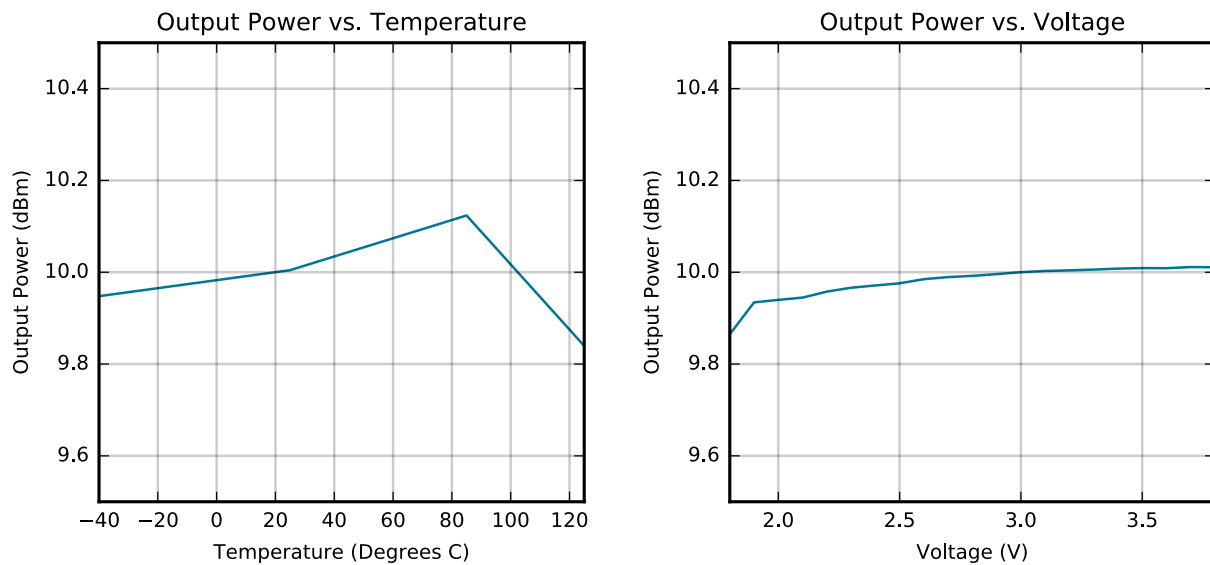
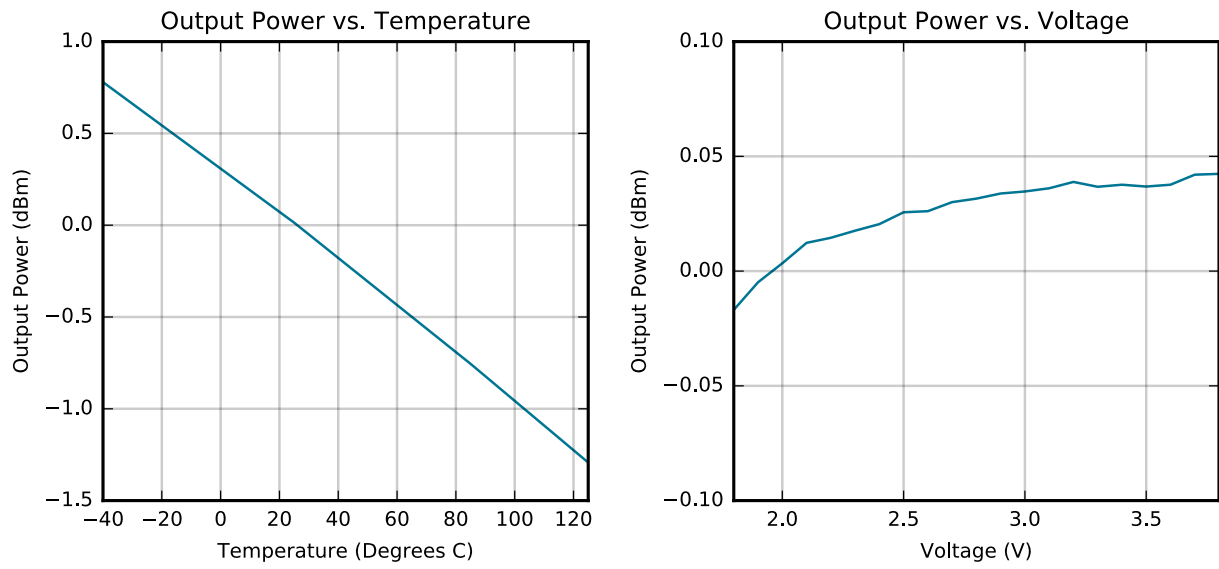
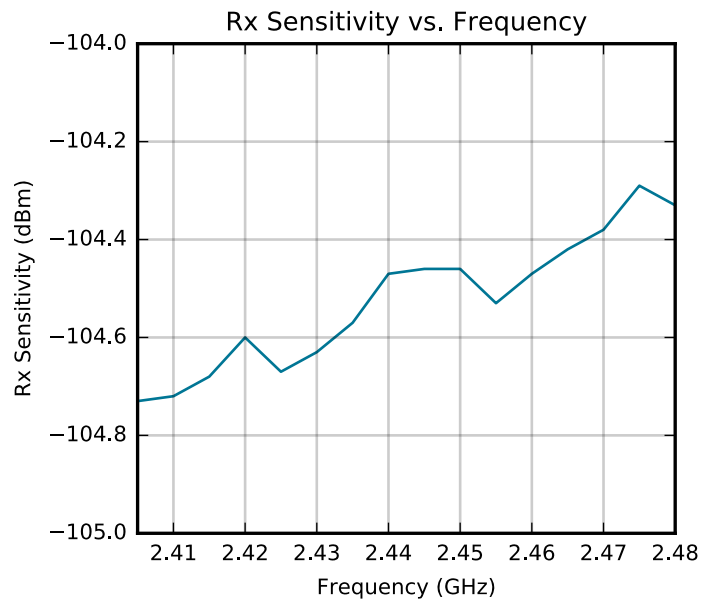

Figure 4.4. 2.4 GHz 10 dBm PA RF Transmitter Output Power



**Figure 4.5. 2.4 GHz 0 dBm PA RF Transmitter Output Power**



**Figure 4.6. 2.4 GHz 802.15.4 RF Receiver Sensitivity**

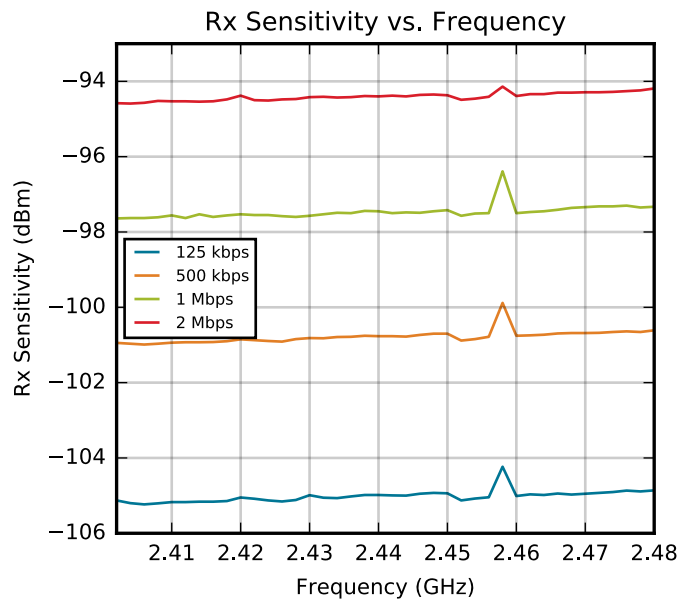

Figure 4.7. 2.4 GHz BLE RF Receiver Sensitivity

## 5. Typical Connection Diagrams

### 5.1 Power

Typical power supply connections are shown in the following figure.

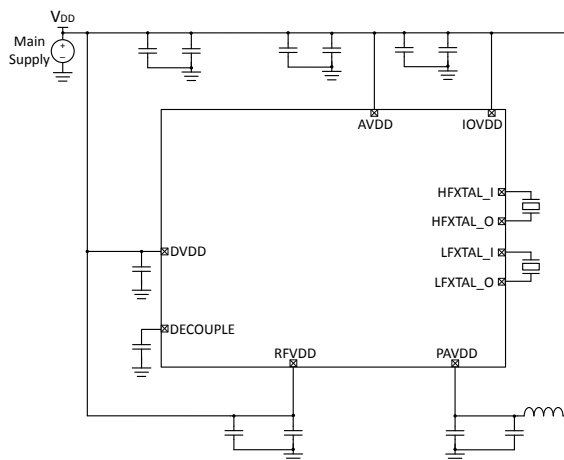

Figure 5.1. EFR32MG21 Typical Application Circuit: Direct Supply Configuration

### 5.2 RF Matching Networks

#### 5.2.1 2.4 GHz 0 dBm Matching Network

The recommended RF matching network circuit diagram for 2.4GHz applications with a transmit power of 0 dBm or less is shown in [Figure 5.2 Typical 0 dBm 2.4 GHz RF impedance-matching network circuit on page 60](#). Typical component values are shown in [Table 5.1 2.4GHz 0 dBm Component Values on page 60](#). Please refer to the development board Bill of Materials for specific part recommendation including tolerance, component size, recommended manufacturer, and recommended part number.

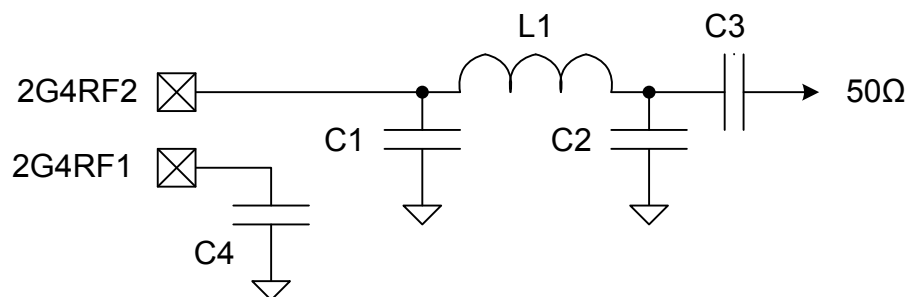

Figure 5.2. Typical 0 dBm 2.4 GHz RF impedance-matching network circuit

Table 5.1. 2.4GHz 0 dBm Component Values

Designator	Value
C1	1.7 pF
C2	0.9 pF
L1	2.0 nH
C3	2.7 pF
C4	0.5 pF

### 5.2.2 2.4 GHz 10 dBm Matching Network

The recommended RF matching network circuit diagram for 2.4GHz applications with a transmit power of greater than 0 dBm and up to 10 dBm is shown in [Figure 5.3 Typical 10 dBm 2.4 GHz RF impedance-matching network circuit on page 61](#). Typical component values are shown in [Table 5.2 2.4GHz 10 dBm Component Values on page 61](#). Please refer to the development board Bill of Materials for specific part recommendation including tolerance, component size, recommended manufacturer, and recommended part number.

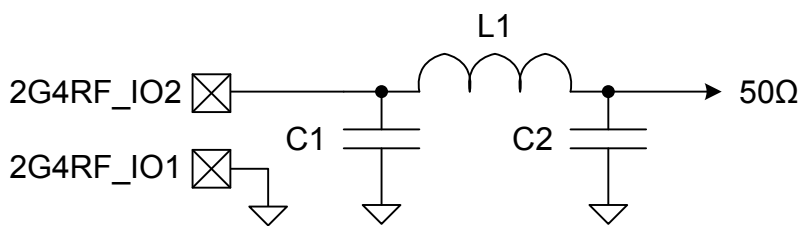

Figure 5.3. Typical 10 dBm 2.4 GHz RF impedance-matching network circuit

Table 5.2. 2.4GHz 10 dBm Component Values

Designator	Value
C1	1.9 pF
L1	2.1 nH
C2	0.9 pF

### 5.2.3 2.4 GHz 20 dBm Matching Network

For part numbers which support the high-power 20 dBm PA, the recommended RF matching network circuit diagram for 2.4GHz applications with a transmit power of greater than 10 and up to 20 dBm is shown in [Figure 5.4 Typical 20 dBm 2.4 GHz RF impedance-matching network circuit on page 62](#). Typical component values are shown in [Table 5.3 2.4GHz 20 dBm Component Values on page 62](#). Please refer to the development board Bill of Materials for specific part recommendation including tolerance, component size, recommended manufacturer, and recommended part number.

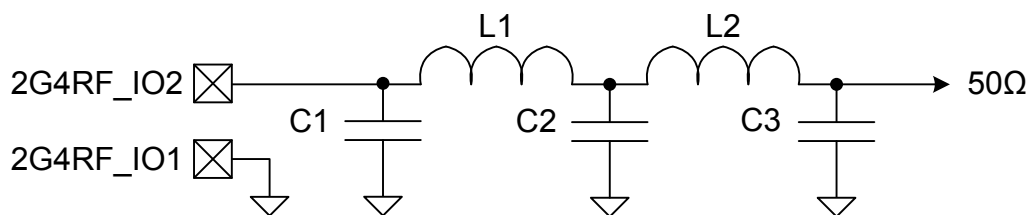

Figure 5.4. Typical 20 dBm 2.4 GHz RF impedance-matching network circuit

Table 5.3. 2.4GHz 20 dBm Component Values

Designator	Value
C1	2.3 pF
L1	2.3 nH
C2	0.8 pF
L2	1.1 nH
C3	0.3 pF

### 5.3 Other Connections

Other components or connections may be required to meet the system-level requirements. Application Note AN0002: "Hardware Design Considerations" contains detailed information on these connections. Application Notes can be accessed on the Silicon Labs website ([www.silabs.com/32bit-appnotes](http://www.silabs.com/32bit-appnotes)).

## 6. Pin Definitions

### 6.1 QFN32 2.4GHz Device Pinout

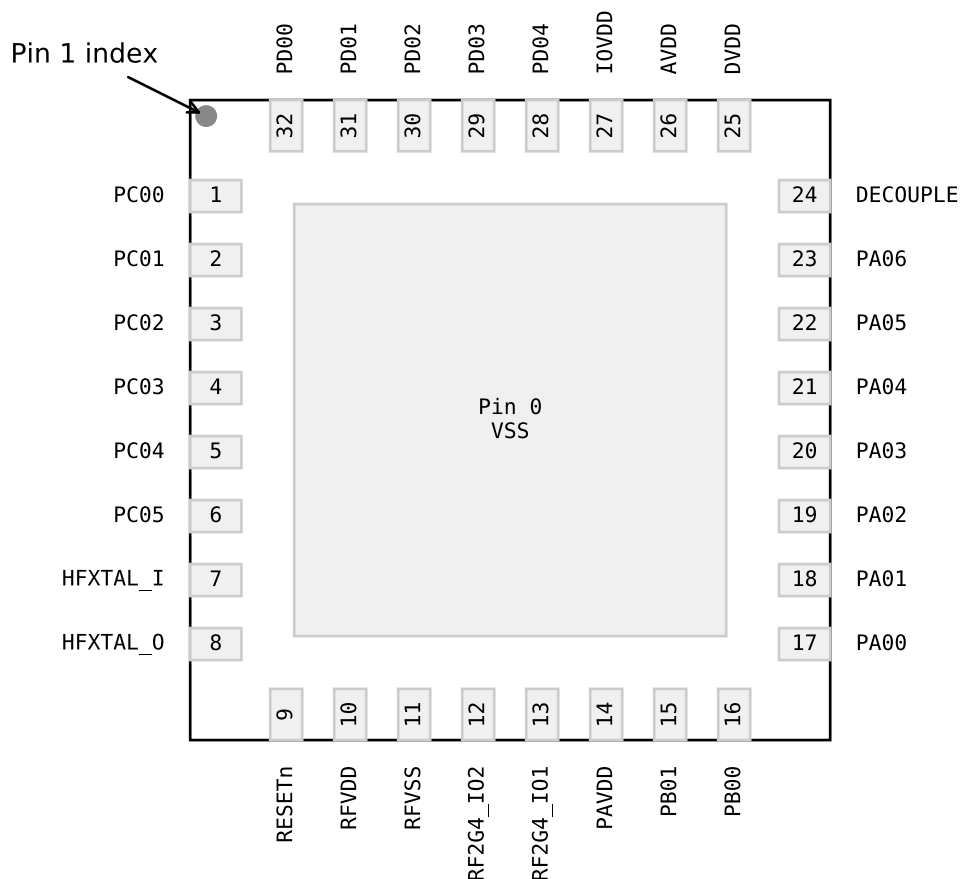

**Figure 6.1. QFN32 2.4GHz Device Pinout**

The following table provides package pin connections and general descriptions of pin functionality. For detailed information on the supported features for each GPIO pin, see [6.2 Alternate Function Table](#), [6.3 Analog Peripheral Connectivity](#), and [6.4 Digital Peripheral Connectivity](#).

**Table 6.1. QFN32 2.4GHz Device Pinout**

Pin Name	Pin(s)	Description	Pin Name	Pin(s)	Description
PC00	1	GPIO	PC01	2	GPIO
PC02	3	GPIO	PC03	4	GPIO
PC04	5	GPIO	PC05	6	GPIO
HFXTAL_I	7	High Frequency Crystal Input	HFXTAL_O	8	High Frequency Crystal Output
RESETn	9	Reset Pin	RFVDD	10	Radio power supply

Pin Name	Pin(s)	Description	Pin Name	Pin(s)	Description
RFVSS	11	Radio Ground	RF2G4_IO2	12	2.4 GHz RF input/output
RF2G4_IO1	13	2.4 GHz RF input/output	PAVDD	14	Power Amplifier (PA) power supply
PB01	15	GPIO	PB00	16	GPIO
PA00	17	GPIO	PA01	18	GPIO
PA02	19	GPIO	PA03	20	GPIO
PA04	21	GPIO	PA05	22	GPIO
PA06	23	GPIO	DECOUPLE	24	Decouple output for on-chip voltage regulator. An external decoupling capacitor is required at this pin.
DVDD	25	Digital power supply	AVDD	26	Analog power supply
IOVDD	27	Digital IO power supply.	PD04	28	GPIO
PD03	29	GPIO	PD02	30	GPIO
PD01	31	GPIO	PD00	32	GPIO

## 6.2 Alternate Function Table

A wide selection of alternate functionality is available for multiplexing to various pins. The following table shows what functions are available on each device pin.

**Table 6.2. GPIO Alternate Function Table**

GPIO	Alternate Function				
PC00	GPIO.EM4WU6				
PC05	GPIO.EM4WU7				
PB01	GPIO.EM4WU3				
PA01	GPIO.SWCLK				
PA02	GPIO.SWDIO				
PA03	GPIO.SWV	GPIO.TDO	GPIO.TRACEDA-TA0		
PA04	GPIO.TDI	GPIO.TRACECLK			
PA05	GPIO.EM4WU0				
PD02	GPIO.EM4WU9				
PD01	LFXO.LFXTAL_I	LFXO.LF_EXTCLK			
PD00	LFXO.LFXTAL_O				



### 6.3 Analog Peripheral Connectivity

Many analog resources are routable and can be connected to numerous GPIO's. The table below indicates which peripherals are available on each GPIO port. When a differential connection is being used Positive inputs are restricted to the EVEN pins and Negative inputs are restricted to the ODD pins. When a single ended connection is being used positive input is available on all pins. See the device Reference Manual for more details on the ABUS and analog peripherals.

**Table 6.3. ABUS Routing Table**

Peripheral	Signal	PA		PB		PC		PD	
		EVEN	ODD	EVEN	ODD	EVEN	ODD	EVEN	ODD
ACMP0	ana_neg	Yes	Yes	Yes	Yes	Yes	Yes	Yes	Yes
	ana_pos	Yes	Yes	Yes	Yes	Yes	Yes	Yes	Yes
ACMP1	ana_neg	Yes	Yes	Yes	Yes	Yes	Yes	Yes	Yes
	ana_pos	Yes	Yes	Yes	Yes	Yes	Yes	Yes	Yes
IADC0	ana_neg	Yes	Yes	Yes	Yes	Yes	Yes	Yes	Yes
	ana_pos	Yes	Yes	Yes	Yes	Yes	Yes	Yes	Yes

## 6.4 Digital Peripheral Connectivity

Many digital resources are routable and can be connected to numerous GPIO's. The table below indicates which peripherals are available on each GPIO port.

**Table 6.4. DBUS Routing Table**

Peripheral.Resource	PORT			
	PA	PB	PC	PD
ACMP0.DIGOUT	Available	Available	Available	Available
ACMP1.DIGOUT	Available	Available	Available	Available
CMU.CLKIN0			Available	Available
CMU.CLKOUT0			Available	Available
CMU.CLKOUT1			Available	Available
CMU.CLKOUT2	Available	Available		
FRC.DCLK			Available	Available
FRC.DFRAME			Available	Available
FRC.DOUT			Available	Available
I2C0.SCL	Available	Available	Available	Available
I2C0.SDA	Available	Available	Available	Available
I2C1.SCL			Available	Available
I2C1.SDA			Available	Available
LETIMER0.OUT0	Available	Available		
LETIMER0.OUT1	Available	Available		
MODEM.ANT0	Available	Available	Available	Available
MODEM.ANT1	Available	Available	Available	Available
MODEM.DCLK	Available	Available		
MODEM.DIN	Available	Available		
MODEM.DOUT	Available	Available		
PRS.ASYNCH0	Available	Available		
PRS.ASYNCH1	Available	Available		
PRS.ASYNCH10			Available	Available
PRS.ASYNCH11			Available	Available
PRS.ASYNCH2	Available	Available		
PRS.ASYNCH3	Available	Available		
PRS.ASYNCH4	Available	Available		
PRS.ASYNCH5	Available	Available		
PRS.ASYNCH6			Available	Available
PRS.ASYNCH7			Available	Available
PRS.ASYNCH8			Available	Available

Peripheral.Resource	PORT			
	PA	PB	PC	PD
PRS.ASYNCH9			Available	Available
PRS.SYNCH0	Available	Available	Available	Available
PRS.SYNCH1	Available	Available	Available	Available
PRS.SYNCH2	Available	Available	Available	Available
PRS.SYNCH3	Available	Available	Available	Available
TIMER0.CC0	Available	Available	Available	Available
TIMER0.CC1	Available	Available	Available	Available
TIMER0.CC2	Available	Available	Available	Available
TIMER0.CDTI0	Available	Available	Available	Available
TIMER0.CDTI1	Available	Available	Available	Available
TIMER0.CDTI2	Available	Available	Available	Available
TIMER1.CC0	Available	Available	Available	Available
TIMER1.CC1	Available	Available	Available	Available
TIMER1.CC2	Available	Available	Available	Available
TIMER1.CDTI0	Available	Available	Available	Available
TIMER1.CDTI1	Available	Available	Available	Available
TIMER1.CDTI2	Available	Available	Available	Available
TIMER2.CC0	Available	Available		
TIMER2.CC1	Available	Available		
TIMER2.CC2	Available	Available		
TIMER2.CDTI0	Available	Available		
TIMER2.CDTI1	Available	Available		
TIMER2.CDTI2	Available	Available		
TIMER3.CC0			Available	Available
TIMER3.CC1			Available	Available
TIMER3.CC2			Available	Available
TIMER3.CDTI0			Available	Available
TIMER3.CDTI1			Available	Available
TIMER3.CDTI2			Available	Available
USART0.CLK	Available	Available	Available	Available
USART0.CS	Available	Available	Available	Available
USART0.CTS	Available	Available	Available	Available
USART0.RTS	Available	Available	Available	Available
USART0.RX	Available	Available	Available	Available
USART0.TX	Available	Available	Available	Available
USART1.CLK	Available	Available		

Peripheral.Resource	PORT			
	PA	PB	PC	PD
USART1.CS	Available	Available		
USART1.CTS	Available	Available		
USART1.RTS	Available	Available		
USART1.RX	Available	Available		
USART1.TX	Available	Available		
USART2.CLK			Available	Available
USART2.CS			Available	Available
USART2.CTS			Available	Available
USART2.RTS			Available	Available
USART2.RX			Available	Available
USART2.TX			Available	Available

## 7. QFN32 Package Specifications

### 7.1 QFN32 Package Dimensions

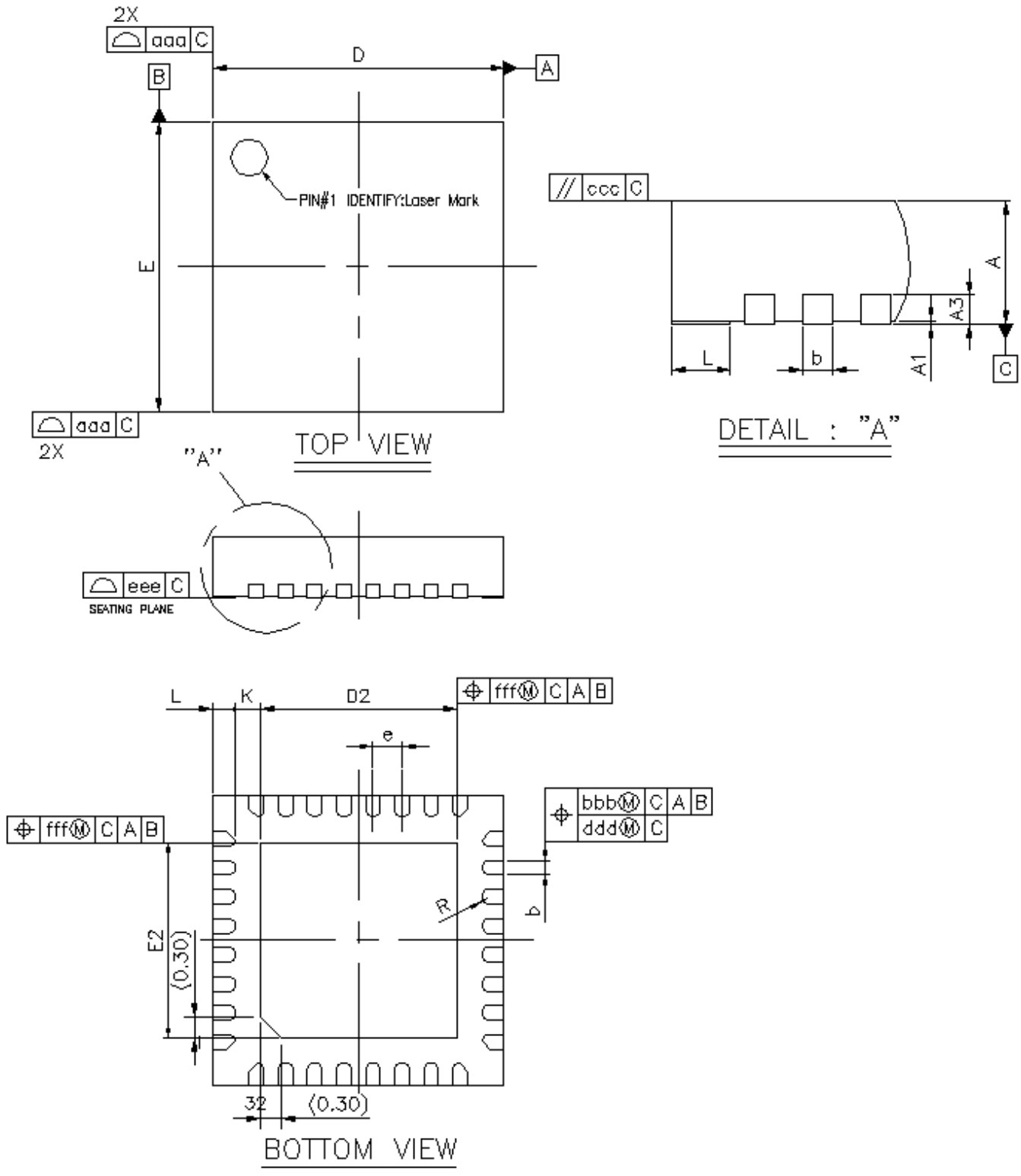

Figure 7.1. QFN32 Package Drawing

**Table 7.1. QFN32 Package Dimensions**

Dimension	Min	Typ	Max
A	0.80	0.85	0.90
A1	0.00	0.02	0.05
A3	0.20 REF		
b	0.15	0.20	0.25
D	3.90	4.00	4.10
E	3.90	4.00	4.10
D2	2.60	2.70	2.80
E2	2.60	2.70	2.80
e	0.40 BSC		
L	0.20	0.30	0.40
K	0.20	—	—
R	0.075	—	0.125
aaa	0.10		
bbb	0.07		
ccc	0.10		
ddd	0.05		
eee	0.08		
fff	0.10		

**Note:**

1. All dimensions shown are in millimeters (mm) unless otherwise noted.
2. Dimensioning and Tolerancing per ANSI Y14.5M-1994.
3. This drawing conforms to the JEDEC Solid State Outline MO-220, Variation VKKD-4.
4. Recommended card reflow profile is per the JEDEC/IPC J-STD-020 specification for Small Body Components.

## 7.2 QFN32 PCB Land Pattern

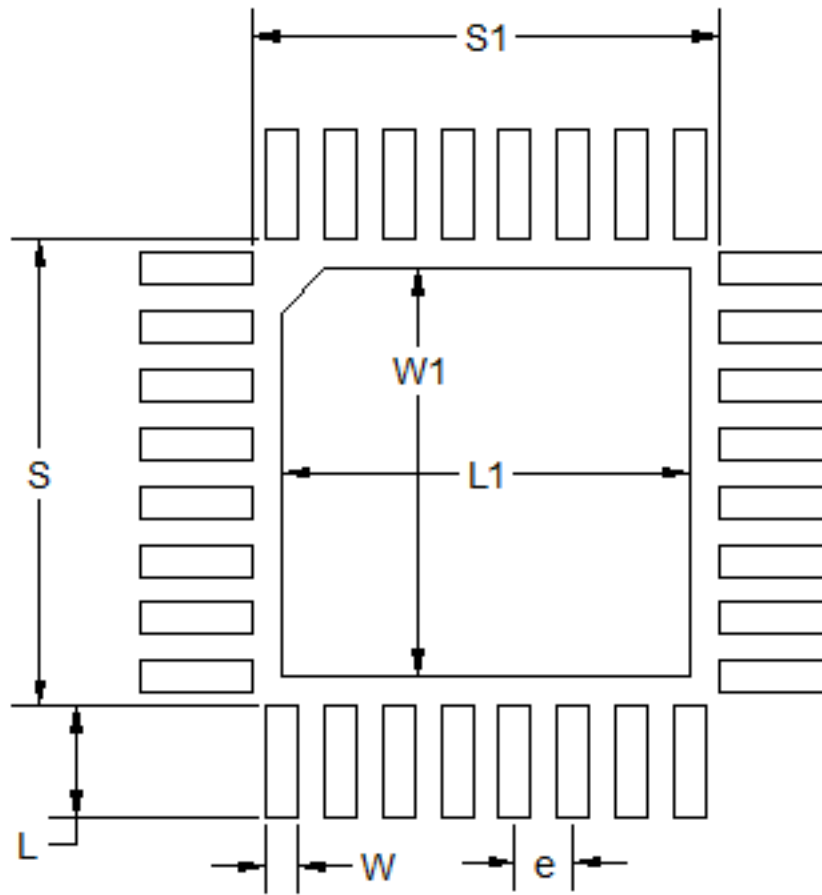

Figure 7.2. QFN32 PCB Land Pattern Drawing

**Table 7.2. QFN32 PCB Land Pattern Dimensions**

Dimension	Typ
L	0.76
W	0.22
e	0.40
S	3.21
S1	3.21
L1	2.80
W1	2.80

**Note:**

1. All dimensions shown are in millimeters (mm) unless otherwise noted.
2. This Land Pattern Design is based on the IPC-7351 guidelines.
3. All metal pads are to be non-solder mask defined (NSMD). Clearance between the solder mask and the metal pad is to be 60  $\mu$ m minimum, all the way around the pad.
4. A stainless steel, laser-cut and electro-polished stencil with trapezoidal walls should be used to assure good solder paste release.
5. The stencil thickness should be 0.101 mm (4 mils).
6. The ratio of stencil aperture to land pad size can be 1:1 for all perimeter pads.
7. A 2x2 array of 1.10 mm x 1.10 mm openings on a 1.30 mm pitch can be used for the center ground pad.
8. A No-Clean, Type-3 solder paste is recommended.
9. The recommended card reflow profile is per the JEDEC/IPC J-STD-020 specification for Small Body Components.
10. **Above notes and stencil design are shared as recommendations only. A customer or user may find it necessary to use different parameters and fine tune their SMT process as required for their application and tooling.**



### 7.3 QFN32 Package Marking

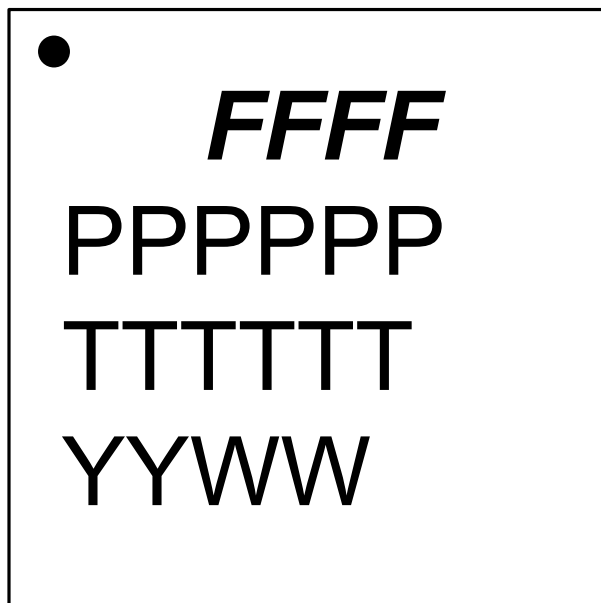

Figure 7.3. QFN32 Package Marking

The package marking consists of:

- FFFF – The product family codes.
  1. Family Code ( B = Blue | M = Mighty | F = Flex )
  2. G (Gecko)
  3. Series (2)
  4. Device Configuration (1, 2, 3, ...)
- PPPPPP – The product option codes.
  - 1-2. MCU Feature Codes
  - 3-4. Radio Feature Codes
  - 5. Flash ( J = 1024k | I = 768k | H = 512k | W = 352k | G = 256k | F = 128k )
  - 6. Temperature grade ( G = -40 to 85 °C | I = -40 to 125 °C )
- TTTTTT – A trace or manufacturing code. The first letter is the device revision.
- YY – The last 2 digits of the assembly year.
- WW – The 2-digit workweek when the device was assembled.

## 8. Revision History

### Revision 1.1

September, 2019

- Updated the block diagram in the front page with new security features.
- Updated [1. Feature List](#) with new security features.
- Replaced 'Standard' with 'Secure Element' under the Security column in [Table 2.1 Ordering Information on page 3](#).
- Replaced Security Accelerator with Crypto Accelerator in [Figure 3.1 Detailed EFR32MG21 Block Diagram on page 6](#).
- Updated [3.7 Security Features](#) with more detailed information.
- Replaced 'ADC' with 'IADC' in [3.8.2 Analog to Digital Converter \(IADC\)](#).
- Added the payload size under the Test Conditions of the parameter Sensitivity in [Table 4.16 RF Receiver Characteristics for Bluetooth Low Energy in the 2.4 GHz Band 1 Mbps Data Rate on page 33](#) and [Table 4.17 RF Receiver Characteristics for Bluetooth Low Energy in the 2.4 GHz Band 2 Mbps Data Rate on page 34](#)
- Corrected the units in [Table 5.3 2.4GHz 20 dBm Component Values on page 62](#).
- Added PC00 to [Table 6.2 GPIO Alternate Function Table on page 64](#).
- Fixed minor typos throughout the document.

### Revision 1.0

March, 2019

- Added Minimum and Maximum values to electrical specification tables.
- Updated BLE 125k and 500 kbps RF specifications to reflect latest silicon.
- Updated 20 dBm Tx RF specifications to reflect latest silicon.
- Added typical Curves.
- Added RF Matching networks.
- Updated RF specifications to reflect latest silicon.
- Updated typical specification values to reflect latest silicon.
- Wording, spelling, and grammar fixes.

### Revision 0.5

February, 2019

- Added Flash electrical specification table.
- Added typical specification values for 20 dBm and 0 dBm PAs.
- Updated typical specification values for RF current consumption to reflect latest silicon.
- Wording, spelling, and grammar fixes.

### Revision 0.42

January, 2019

- Updated typical values for all parameters, including RF parameters.
- Updated specification tables to reflect updated specification list.
- Wording, spelling, and grammar fixes.
- Synchronized revisions for all datasheets in device family.

### Revision 0.4

July, 2018

- Updated specification tables to reflect updated specification list and inserted new specification tables.
- Updated typical values for key parameters.
- Wording, spelling, and grammar fixes.

**Revision 0.1**

May, 2018

Initial Release

Silicon Labs

# Simplicity Studio™4



## Simplicity Studio

One-click access to MCU and wireless tools, documentation, software, source code libraries & more. Available for Windows, Mac and Linux!



**IoT Portfolio**  
[www.silabs.com/IoT](http://www.silabs.com/IoT)



**SW/HW**  
[www.silabs.com/simplicity](http://www.silabs.com/simplicity)



**Quality**  
[www.silabs.com/quality](http://www.silabs.com/quality)



**Support and Community**  
[community.silabs.com](http://community.silabs.com)

### Disclaimer

Silicon Labs intends to provide customers with the latest, accurate, and in-depth documentation of all peripherals and modules available for system and software implementers using or intending to use the Silicon Labs products. Characterization data, available modules and peripherals, memory sizes and memory addresses refer to each specific device, and "Typical" parameters provided can and do vary in different applications. Application examples described herein are for illustrative purposes only. Silicon Labs reserves the right to make changes without further notice to the product information, specifications, and descriptions herein, and does not give warranties as to the accuracy or completeness of the included information. Without prior notification, Silicon Labs may update product firmware during the manufacturing process for security or reliability reasons. Such changes will not alter the specifications or the performance of the product. Silicon Labs shall have no liability for the consequences of use of the information supplied in this document. This document does not imply or expressly grant any license to design or fabricate any integrated circuits. The products are not designed or authorized to be used within any FDA Class III devices, applications for which FDA premarket approval is required or Life Support Systems without the specific written consent of Silicon Labs. A "Life Support System" is any product or system intended to support or sustain life and/or health, which, if it fails, can be reasonably expected to result in significant personal injury or death. Silicon Labs products are not designed or authorized for military applications. Silicon Labs products shall under no circumstances be used in weapons of mass destruction including (but not limited to) nuclear, biological or chemical weapons, or missiles capable of delivering such weapons. Silicon Labs disclaims all express and implied warranties and shall not be responsible or liable for any injuries or damages related to use of a Silicon Labs product in such unauthorized applications.

### Trademark Information

Silicon Laboratories Inc.®, Silicon Laboratories®, Silicon Labs®, SiLabs® and the Silicon Labs logo®, Bluegiga®, Bluegiga Logo®, ClockBuilder®, CMEMS®, DSPLL®, EFM®, EFM32®, EFR, Ember®, Energy Micro, Energy Micro logo and combinations thereof, "the world's most energy friendly microcontrollers", Ember®, EZLink®, EZRadio®, EZRadioPRO®, Gecko®, Gecko OS, Gecko OS Studio, ISOModem®, Precision32®, ProSLIC®, Simplicity Studio®, SiPHY®, Telegesis, the Telegesis Logo®, USBXpress®, Zentri, the Zentri logo and Zentri DMS, Z-Wave®, and others are trademarks or registered trademarks of Silicon Labs. ARM, CORTEX, Cortex-M3 and THUMB are trademarks or registered trademarks of ARM Holdings. Keil is a registered trademark of ARM Limited. Wi-Fi is a registered trademark of the Wi-Fi Alliance. All other products or brand names mentioned herein are trademarks of their respective holders.



**Silicon Laboratories Inc.**  
400 West Cesar Chavez  
Austin, TX 78701  
USA

<http://www.silabs.com>

# Mouser Electronics

Authorized Distributor

Click to View Pricing, Inventory, Delivery & Lifecycle Information:

## Silicon Laboratories:

[EFR32MG21A020F1024IM32-BR](#) [EFR32MG21A020F512IM32-B](#) [EFR32MG21A020F512IM32-BR](#)  
[EFR32MG21A010F1024IM32-B](#) [EFR32MG21A010F1024IM32-BR](#) [EFR32MG21A010F512IM32-B](#)  
[EFR32MG21A010F512IM32-BR](#) [EFR32MG21A020F768IM32-B](#) [EFR32MG21A020F768IM32-BR](#)  
[EFR32MG21A010F768IM32-B](#) [EFR32MG21A010F768IM32-BR](#) [EFR32MG21A020F1024IM32-B](#)  
[EFR32MG21B020F512IM32-BR](#) [EFR32MG21B010F512IM32-BR](#) [EFR32MG21B020F768IM32-B](#)  
[EFR32MG21B020F1024IM32-B](#) [EFR32MG21B020F1024IM32-BR](#) [EFR32MG21B020F512IM32-B](#)  
[EFR32MG21B010F512IM32-B](#) [EFR32MG21B010F1024IM32-BR](#) [EFR32MG21B010F768IM32-BR](#)  
[EFR32MG21B010F768IM32-B](#) [EFR32MG21B020F768IM32-BR](#) [EFR32MG21B010F1024IM32-B](#)